

DESCRIPTION The μPA68H is designed for use in the top stage for differential amplifier of a stereo main amplifier.

- FEATURES**
- Excellent pair balance
 $\Delta V_{GS} = 20\text{mV MAX.}$
@ $V_{DS} = 10\text{V}$, $I_D = 1.0\text{mA}$, $\Delta V_{GS} = V_{GS(L)} - V_{GS(S)}$
 $|Y_{fs}|$ Ratio; 0.95 MIN.
@ $V_{DS} = 10\text{V}$, $I_D = 1.0\text{mA}$
 - High bleakdown voltage.
 $V_{GDO} > 50\text{V}$

ABSOLUTE MAXIMUM RATINGS (Ta = 25°C)

- Maximum Temperatures
Storage Temperature - 55 to +125°C
Junction Temperature +125°C Maximum
- Maximum Power Dissipation
Total Power Dissipation 250mW/Unit
- Maximum Voltages and Currents
 V_{GDO} Gate to Drain Voltage - 50 V
 V_{GSO} Gate to Source Voltage - 50 V
 V_{DSX}^* Drain to Source Voltage 50 V
 I_D Drain Current 30 mA
 I_G Gate Current 10 mA
* $V_{GS} = -3.0\text{V}$

PACKAGE DIMENSIONS (Unit : mm)

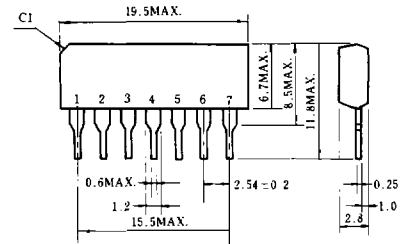

1. Drain 1
2. Gate 1
3. Source 1
4. Sub.
5. Source 2
6. Gate 2
7. Drain 2

ELECTRICAL CHARACTERISTICS (Ta = 25°C)

SYMBOL	CHARACTERISTIC	MIN.	TYP.	MAX.	UNIT	TEST CONDITIONS
I_{DSS}	Drain Current	1.0		18	mA	$V_{DS} = 10\text{V}$, $V_{GS} = 0$
$I_{DSS(S)}$	Drain Current Ratio	0.9		1.0		$V_{DS} = 10\text{V}$, $V_{GS} = 0$
$I_{DSS(L)}$						$I_{DSS(S)}/I_{DSS(L)}^*$
$ Y_{fs} $	Forward Transfer Admittance	5.0	7.0		mΩ	$V_{DS} = 10\text{V}$, $I_D = 1.0\text{mA}$, $f = 1.0\text{kHz}$
$ Y_{fs} (S)$	Forward Transfer Admittance Ratio	0.95		1.0		$V_{DS} = 10\text{V}$, $I_D = 1.0\text{mA}$, $f = 1.0\text{kHz}$
$ Y_{fs} (L)$						$ Y_{fs} (S)/ Y_{fs} (L)^*$
ΔV_{GS}	Gate to Source Voltage Difference		3.0	20	mV	$V_{DS} = 10\text{V}$, $I_D = 1.0\text{mA}$ $\Delta V_{GS} = V_{GS(L)} - V_{GS(S)}^*$
NV	Noise Voltage		25	35	mV	See Test Circuit
C_{iss}	Input Capacitance		15		pF	$V_{DS} = 10\text{V}$, $V_{GS} = 0$, $f = 1.0\text{MHz}$
C_{rss}	Feedback Capacitance		3.0		pF	$V_{DS} = 10\text{V}$, $V_{GS} = 0$, $f = 1.0\text{MHz}$
$V_{GS(off)}$	Gate to Source Cutoff Voltage	-0.15		-2.5	V	$V_{DS} = 10\text{V}$, $I_D = 10\mu\text{A}$
I_{GSS}	Gate Cutoff Current			-1.0	nA	$V_{GS} = -20\text{V}$, $V_{DS} = 0$

* (S) : The Smaller Value, (L) : The Larger of the pair

Classification of I_{DSS}

Rank	K	L	M	N
$I_{DSS}(\text{mA})$	1.0 - 6.0	5.0 - 10	9.0 - 14	13 - 18

I_{DSS} Test Conditions : $V_{DS} = 10\text{V}$, $V_{GS} = 0$

TYPICAL CHARACTERISTICS (Ta = 25°C)

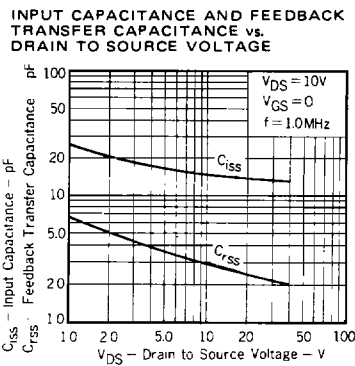
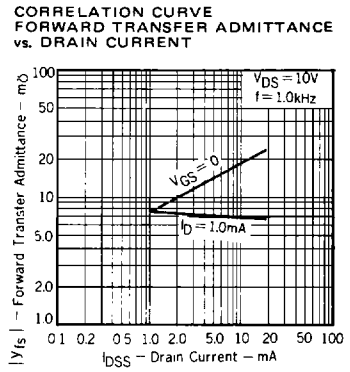
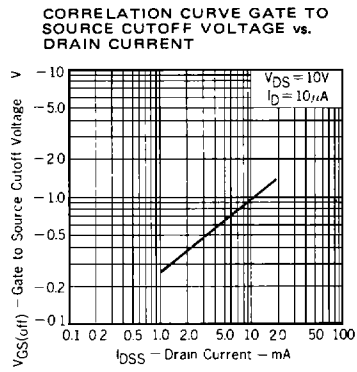
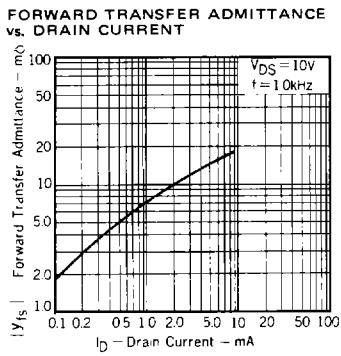
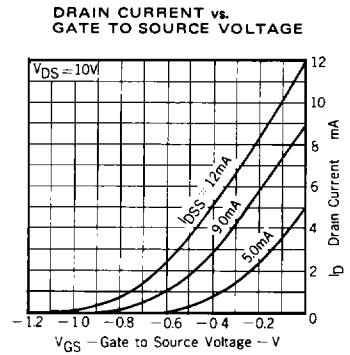
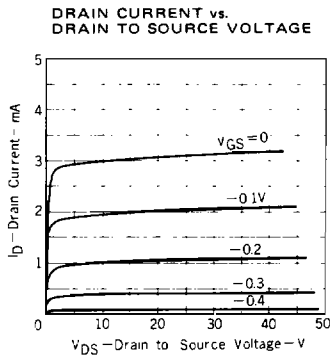
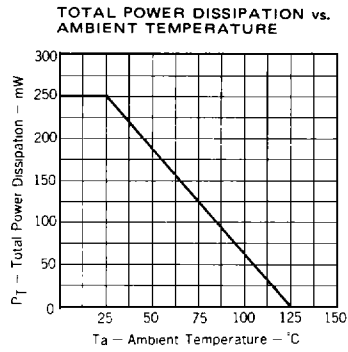

NOISE VOLTAGE TEST CIRCUIT

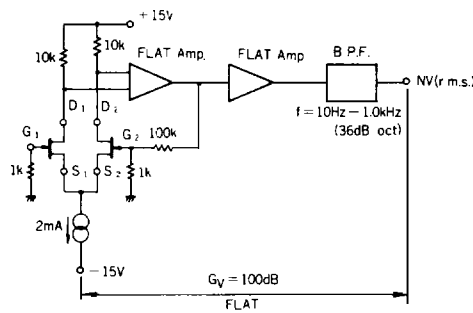

LEAD CONNECTION

