

THE "AVO"
VALVE CHARACTERISTIC METER

Mk. IV.

WORKING INSTRUCTIONS

FIRST EDITION



PUBLISHED BY

AVO LIMITED,

AVOCET HOUSE, 92-96 VAUXHALL BRIDGE ROAD, LONDON, S.W.1

Telephone: VICTORIA 3404 (12 lines)



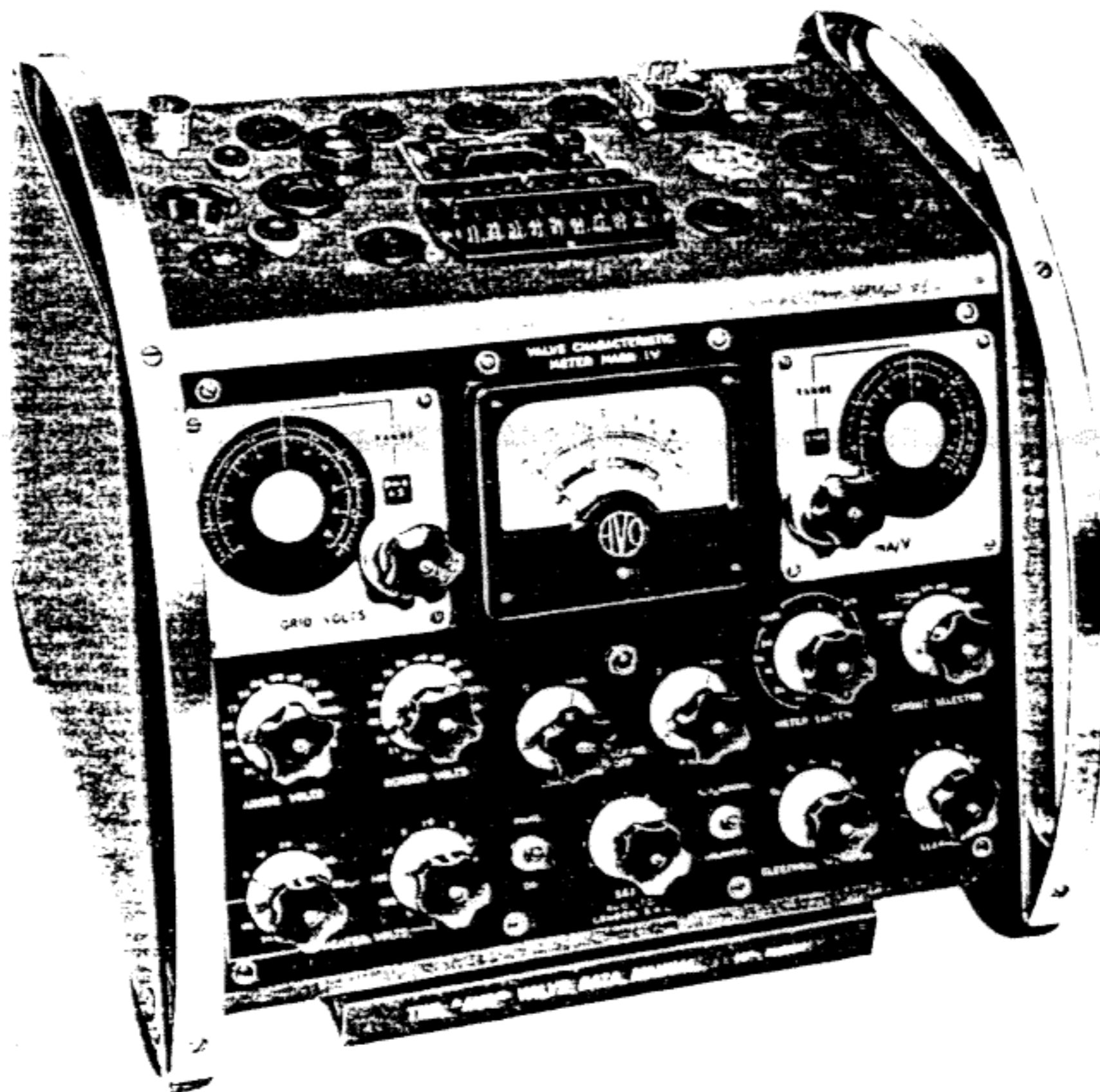

"AVO" VALVE CHARACTERISTIC METER Mk. IV.

FOREWORD

FOR more than a quarter of a century we have been engaged in the design and manufacture of "AVO" Electrical Measuring Instruments. Throughout that time we have consistently pioneered the design of modern multi-range instruments and have kept abreast of and catered for the requirements of the epoch-making developments in the fields of radio and electronics.

The success of our steadfast policy of maintaining high standards of performance in instruments of unexcelled accuracy, and making such instruments available at reasonable cost, is reflected in the great respect and genuine goodwill which "AVO" products enjoy in every part of the World.

It has been gratifying to note the very large number of instances where the satisfaction obtained from the performance of one of our instruments has led to the automatic choice of other instruments from the "AVO" range. This process, having continued over a long period of years, has resulted in virtual standardisation on our products by numerous Public Bodies, The Services, Railway Systems, and Post Office and Telegraph Undertakings throughout the world.

Our designers have thereby been encouraged to ensure that new instruments or accessories for inclusion in the "AVO" range fit in with existing "AVO" apparatus and serve to extend the usefulness of instruments already in use. Thus, the user who standardises on "AVO" products will seldom find himself short of essential measuring equipment, for, by means of suitable accessories, his existing equipment can often be adapted to meet unusual demands.

It is with pleasure that we acknowledge that the unique position attained by "AVO" is due in no small measure to the co-operation of so many users who stimulate our Research and Development staffs from time to time with suggestions, criticisms, and even requests for the production of entirely new instruments or accessories. It is our desire to encourage and preserve this relationship between those who use "AVO" Instruments and those who are responsible for their design and manufacture, and correspondence is therefore welcomed, whilst suggestions will receive prompt and sympathetic consideration.

INDEX

Foreword	3
Introduction	5
The Basic Method of characteristic checking	7
The Basic Method of checking diodes and rectifiers	7
Insulation Testing	8
The Protective Relay	9
The Valve Panel and Selector Switch	9
Procedure for setting up valve base connections	10
Provision for new valve bases	12
The prevention of Self oscillation of valves under test...	12
Diagram of Standard base pin connections	13
Procedure for valves having internally connected pins...	14
The controls on the front panel, their functions and operations	14
The Set ~ Control	15
The Leakage Switch	15
The Circuit Selector Switch	15
The Anode and Screen Voltage Switches	16
The Heater Voltage Switches	16
The Negative Grid Voltage Controls	16
The Backing Off Controls	16
The Meter Switch	16
The Set mA/V Control	16
The Electrode Selector Switch	17
The Mains Adjustment Panel at the rear of the Instrument	17
General Procedure for testing a valve	17
Mains voltage adjustment and panel set up—cold and hot leakage tests—mutual characteristic checks and gas tests—diode and rectifier tests made under load.	
Instructions for testing specific valve types	21
Multiple diodes and rectifiers—double triodes, double pentodes and double tetrodes—combined diode and amplifying valves—frequency changers of heptode and hexode types—frequency changers employing separate electrode assemblies.	
The Use of the Links on the Valve Panel of the Instrument	23
Tuning Indicators (Magic Eyes)	23
Gaseous Rectifiers	24
Cold Cathode Rectifiers	24
Thyratrons	24
Neon Indicators	24
General Precautions to be observed when using the Valve Characteristic Meter	25
Abbreviated Working Instructions for the "AVO" Valve Characteristic Meter Mk. III	26
Circuit diagram of Valve Characteristic Meter	

The "AVO" Valve Data Manual and Handbook

This instrument will produce maximum information when used in conjunction with the Valve Manufacturer's Graphs and Technical Data, but to enable rapid checks to be made relative to a valve's general efficiency, the "AVO" Valve Data Manual (civilian valve types) and the "AVO" Valve Data Handbook (service valve types) have been produced.

This instruction book refers throughout to the "AVO" Valve Data Manual, a copy of which should always be kept with the instrument. New editions of this data manual will be published from time to time. Watch our advertisements in the technical press for further announcements.

Introduction
to
THE "AVO" VALVE CHARACTERISTIC METER Mk. IV

The problem of designing a Valve Testing Instrument capable of giving a true and comprehensive picture of the state of any valve, has always been one of considerable magnitude, increasing in complexity as new valve types are brought into general use.

For a quick general purpose test necessitating a minimum of time and technical effort a mutual conductance figure will give an adequate idea of a valve's usefulness, and the original "AVO" Valve Tester was designed to test the efficiency of valves on this basis.

Whilst a Valve Tester must, of necessity, be accompanied by a data book correlating the results of the Tester with the condition of the valve in question, a purely empirical figure, if used as a standard, will always give rise to doubts in the mind of the operator. The instrument should therefore, produce a figure which can be compared with some standard quoted by the valve manufacturer, if the operator is to use his instrument with confidence. For this reason the "AVO" Valve Tester used the static zero bias mutual conductance figure as a basis of comparison, this figure being at that time almost universally quoted by the valve manufacturer.'

In order to reproduce this standard correctly, it was also necessary to reproduce the stated values of DC anode and screen voltage, a matter of some considerable difficulty when it is realised that for any stated condition of anode and/or screen volts the corresponding electrode currents can vary over very wide limits, and in the case of valves of low initial anode current and high slope, the actuation of the control which produces the milliamp-per-volt reading might easily double the anode current flowing. With DC methods of testing the inherent internal resistance of the rectifying circuits used could be such as to give regulation errors which could cause results to be meaningless unless complicated thermionic stabilising circuits and a vast array of monitoring meters were used in all voltage supply circuits. Such complications would not only render the Tester of prohibitive price and size, but would considerably increase the complication of operation for the non-technical user.

The problem was overcome by the introduction of the AC method of operation (Patent No. 480752) by which means the necessary DC test conditions were correctly simulated and a true mutual conductance figure produced by the application of AC voltages of suitable amplitude to all electrodes. This enormously simplified the power supply problem, rendered regulation errors negligible, and obviated the necessity for voltage circuit monitoring. The "AVO" Valve Tester thus fulfilled normal testing needs for a long period.

During recent years, however, electronic techniques have become much more precise and the nature and multiplicity of valve types have continuously increased. The zero bias mutual conductance figure is seldom quoted by the valve manufacturers, who usually now publish the optimum working point mutual conductance and voltage figures and in a large number of cases give full families of curves, from which precise operation, under a variety of working conditions, can be judged. To cater for present day requirements therefore, a valve testing device should not only be capable of producing a working point mutual conductance figure at any reasonable value of anode, screen or grid voltage recommended by the manufacturers, but should also be capable, if necessary, of reproducing any one of the mutual characteristics associated with the valve in question. The instrument thus has

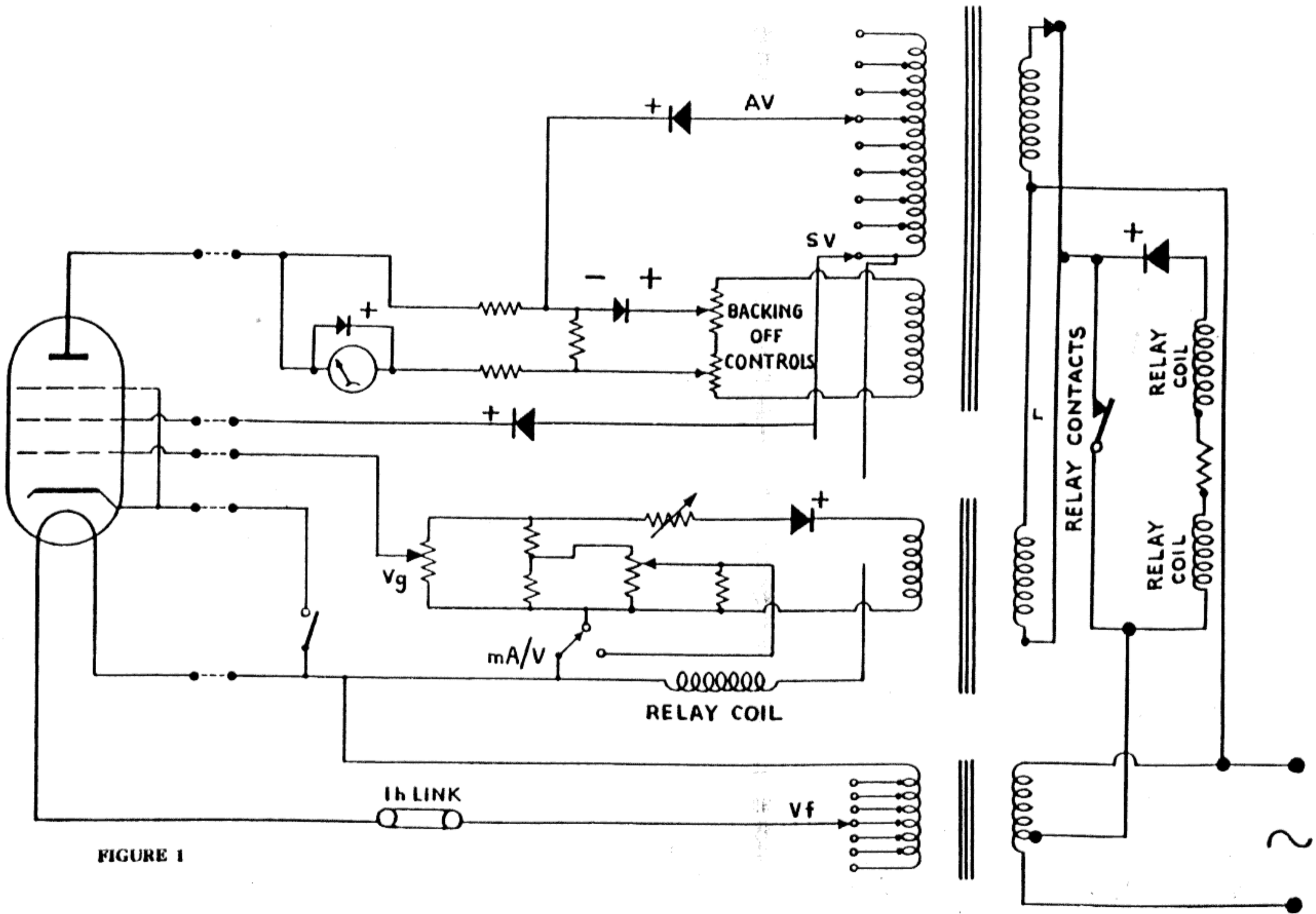

FIGURE 1

to simulate the performance of a comprehensive valve measuring set-up of laboratory type and yet, at the same time, be sufficiently cheap and simple to cater for the needs of the comparatively inexperienced radio test assistant. It is obvious that the very much wider application of an instrument of this class, would render the regulation difficulties, already referred to, much more critical.

Investigations were, therefore, put in hand to see whether the AC test method would reproduce DC conditions not only in respect of the mutual conductance figure taken at a single discrete point, but at all points on all characteristics from zero bias to cut off. In other words, it was necessary to determine whether the general function for a DC static valve characteristic

$$I_a = f \frac{(V_a + \mu_1 V_{g_1} + \mu_2 V_{g_2})}{R_a}$$

would hold when I_a was measured in terms of DC current, but when V_a , V_{g_2} and, if necessary, V_{g_1} , were replaced by 50 cycle AC voltages of suitable magnitude and phase. It was eventually found that a complete co-relation between these two sets of conditions was held when the grid voltage took the form of a sinusoidal wave form with the positive half cycle suppressed (in other words, rectified but completely unsmoothed AC), and the following relationships were maintained:—

$$\begin{aligned} V_a \text{ RMS} &= 1.1 V_a \text{ indicated DC} \\ V_{g_2} \text{ RMS} &= 1.1 V_{g_2} \text{ indicated DC} \\ V_{g_1} \text{ (mean unsmoothed)} &= 0.52 V_{g_1} \text{ indicated DC} \\ I_a \text{ (mean DC)} &= 0.5 \text{ indicated } I_a \end{aligned}$$

From the above conditions, therefore, the required relationships were obtained which formed the basis of operation of the Valve Characteristic Meter (Patent No. 606707).

Such an instrument, whilst retaining the advantages of simplicity, size and reasonable price, resultant upon the elimination of complicated regulated DC supply systems and universal monitoring, would have the inherent regulation easily obtained from a well-designed AC transformer. It would enable a valve to be checked at any point on any one of its many mutual characteristics and if necessary would allow a full family of characteristics to be drawn.

The basic method of characteristic checking

The fundamental circuit of operation of the instrument is shown in Figure 1. As in the original Valve Tester, the process of obtaining a direct reading mutual conductance figure is simplified by the introduction of a backing off circuit, which balances out the deflection due to the standing anode current at the desired test conditions prior to the measurement of mutual conductance. It will be noticed that the current flowing in this backing off circuit is similar in wave form, but precisely opposite in phase to the anode current, this eliminating any undesirable ripple that could otherwise become apparent when the meter, after backing off, was set to a sensitive range. To facilitate the measurement of mutual conductance of high slope/short grid base valves and valves requiring a long heater stabilising period, two distinct methods of measurement have been incorporated.

The basic method of checking diodes and rectifiers

Any simple emission test at low applied voltage must necessarily give rise to a purely empirical figure for the valve in question, which cannot necessarily be correlated with any one of the maker's characteristics and which, owing to the fact that it relates to the lower bend portion of the rectifier characteristic may vary very widely for any given type of valve.

The important function of a rectifying valve is that it will, under suitable reservoir load conditions, produce sufficient current to operate the apparatus which it is intended to supply. This fundamental requirement, therefore, is the basis of rectifier testing in the Valve Characteristic Meter. A sufficiently high AC voltage is applied to operate the valve above the bend in its characteristic, and to ensure that its internal voltage drop is negligible. With a suitable reservoir condenser in circuit, the DC load is adjusted to correspond to a number of DC current conditions, i.e. 1mA, 5mA, 15mA, 30mA, 60mA, 120mA and 180mA. The actual current flowing in the load circuit is then indicated on a meter shunted to correspond with the DC load required. The meter reading will then indicate the comparative efficiency of the valve on the basis of the required DC load. Each half of a full wave rectifying valve is tested separately thus enabling the two halves to be checked for matching and any tendency to produce hum by partial half waving to be indicated.

The pre-determined load figures are chosen so that they not only give a sufficiently wide range of currents to cater for the normal requirements of electronic apparatus, but also correspond to the DC maximum emission figures usually quoted by manufacturers in their rectifying valve data.

Signal diode valves are similarly tested, but usually these loads at the 1mA or 5mA load positions, being normally more than sufficient to cover the rectified signal current that would be obtained. The basic operating circuit of the diode and rectifier system is shown in Figure 2.

Insulation Testing

To cover all eventualities, three distinct forms of insulation measurement are catered for in the Valve Characteristic Meter. Measurements are taken with DC applied voltages, and direct indication of the insulation value in megohms is shown on the meter scale. As an initial test, prior to the application of operating voltages to the valve, the rotation of a switch enables the insulation figure to be shown, which occurs between each of the valve

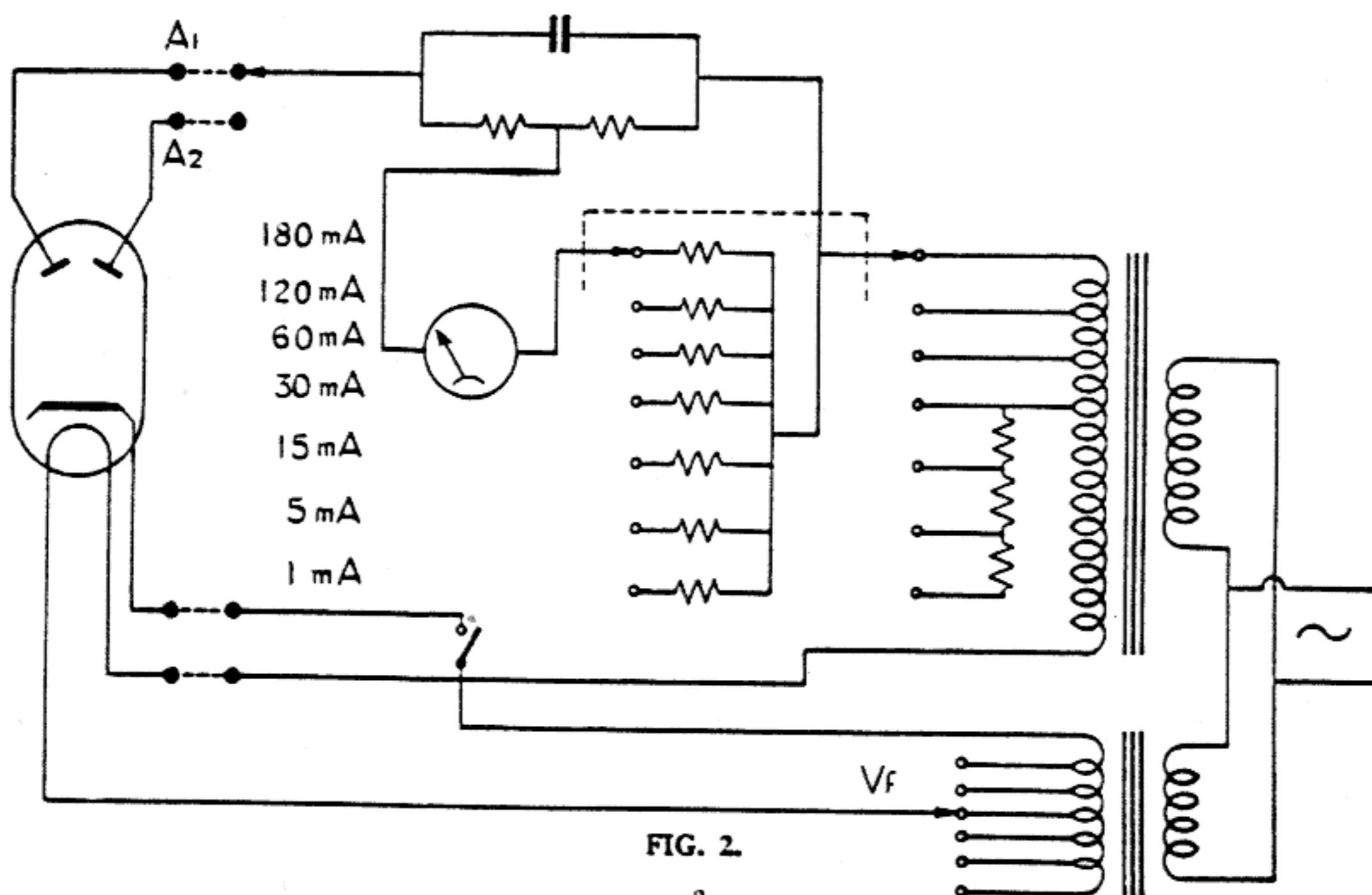

FIG. 2

electrodes taken in order and all the others strapped together. The denomination of the electrodes between which any breakdown exists will thus be automatically indicated and further, the continuity of the heater circuit is shown as a zero resistance at the heater (H) position of the switch.

With the application of heater voltage to directly heated valves, electrode expansion may be sufficient to cause a breakdown between the heater and an adjacent electrode. In the same manner cathode distortion may occur in indirectly heated valves causing similar breakdowns. To show up this condition a test circuit is provided indicating the insulation resistance between the heater and cathode of a valve and all other electrodes strapped when heater voltage has been applied.

Finally the very important factor of heater to cathode insulation when the heater is hot can be tested, the insulation again being shown directly in megohms, the usual cathode to heater connection being opened for this purpose and the applied voltage being in such a direction as to make the cathode negative with respect to the heater, thus avoiding false indications of insulation resistance due to electrode emission.

Protective relay

To prevent damage to the internal components of the valve characteristic meter due to inadvertent or deliberate shorting of the electrode voltages, a protective relay is incorporated which operates when damaging overloads of alternating current are taken from either the anode or screen voltage sources. The relay carries three windings, one in the high tension supply, the remaining windings are "hold-off" coils. Operation of the relay connects a diode in series with the transformer primary winding. This operation places the instrument in a safety condition and normal working cannot be restored until the instrument has been switched off, the fault removed and the instrument switched on again. The relay is entirely self-setting and in consequence no reset mechanism has been incorporated.

NOTE: The relay does not protect the valve when incorrect heater voltages are applied. It must also be stressed that the relay will not operate on the passage of normal heavy current of a DC nature occurring in a valve anode circuit, and it will not protect the movement if the latter is wrongly set on a range too low to accommodate the current passing. This problem can only be dealt with by ensuring that the movement is always set to its maximum current range when the magnitude of the expected current is unknown.

THE VALVE PANEL AND SELECTOR SWITCH

The Valve Panel comprises 17 valve holders of the following types:—English 4/5 pin, 7 and 9 pin, 8 pin side contact, B7G, B8A, B8B. (or B8G) (American Loctal), B9A, B9G, Mazda Octal, B3G. American-4, 5, 6 and small 7 pin UX, medium 7 pin UX, and Octal, facilities have been provided to enable "flying lead" valves to be tested. Provision is made by means of plug-in adaptors to cater for newly introduced valve bases. The valve holders are all wired with their corresponding pins, according to the standard pin numbering, in parallel, i.e., all pins number one are wired together, all pins number two, and so on. This wiring combination is associated with the well-known "AVO" Multi-Way Selector Switch which enables any one of the nine standard pin numbers to be connected to any one of the electrode test circuits in the Valve Characteristic Meter, thus enabling any electrode combination to be set up for any normal valve holder.

It will be seen that the Selector Switch comprises nine thumb control rollers, numbered from left to right 1—9. This numbering appears on the moulded escutcheon immediately behind the rollers and corresponds to the valve pins in the order of their standard pin numbering. Thus valves with any number of base connections up to nine can be accommodated. Further, to accommodate top cap and other external valve connections a socket panel is provided with nine sockets marked G1, S, A1, A2, D1, D2, C, H—, H+, the markings corresponding to the valve electrode connections which are made externally to the valve.

Rotation of the rollers by the finger rim provided will reveal that each roller can be set in any one of ten positions, the setting in question being indicated in the window opening at the front of the escutcheon. The ten positions on the roller are marked as under:—

1	2	3	4	5	6	7	8	9	0
C	H—	H+	G	S	A	A2	D1	D2	—

The numbers are provided for ease of memorising and noting base combinations, but the corresponding electrode denominations are shown by the letter appearing in the escutcheon window immediately underneath the number, thus:—

- (1) C corresponds to Cathode, or to an electrode normally connected to cathode e.g., G3.
- (2) H— „ „ Heater normally Earthy or connected to negative L.T. in the case of a battery valve.
- (3) H+ „ „ the other Heater connection or centre tap.
- (4) G „ „ Control Grid
- (5) S „ „ Screen Grid or g_2 .
- (6) A „ „ normal anode of single or multiple valve. In the case of an Oscillator mixer valve, A represents the Oscillator anode.
- (7) A2 „ „ second anode of double valves, and in the case of Oscillator mixer valves, the mixer anode.
- (8) D1 „ „ the first diode anode of half and full wave signal diode and rectifier valves, diode and rectifier/amplifier combinations.
- (9) D2 „ „ the second diode anode of signal diode and rectifier valves, diode and rectifier/amplifier combinations.
- (0) — „ „ a disconnected valve pin or to a pin upon which an internal electrode is anchored. Such pins are marked "I.C." in manufacturers' literature, or by an asterisk (*) in the "AVO" valve data manual. This switch position leaves the particular valve pin completely disconnected.

Procedure for setting up valve base connections

The standard procedure for setting up a valve ready for test is as follows. From some suitable source i.e. "AVO" Valve Data Manual, Valve Manufacturer's Data Leaflet or published manual of Valve Data, determine, the pin basing connections for the valve, in order of their standard pin numbering. Rotate the rollers of the Selector Switch until the set up number or electrode letter combination appears in the window reading from left to right in order of the standard pin numbering. In the case of valves having less than nine pins, the free rollers on the right of the set up combinations corresponding to non-existent valve electrodes should be set at 0. When the valve is inserted in the appro-

appropriate valve holder, use the universal top cap lead to connect any top cap or side connection on the valve to its appropriately marked socket, on the Socket Panel immediately behind the Selector Switch. Note that the loctal valve holder having only eight normal pins has its centre lug connected to the ninth roller (corresponding to pin No. 9) to accommodate valves which have a cathode connection made to this lug.

The accompanying examples show how to correlate the pin basing data and the equivalent set-up combination for a number of valves in common use.

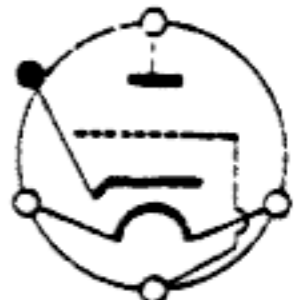
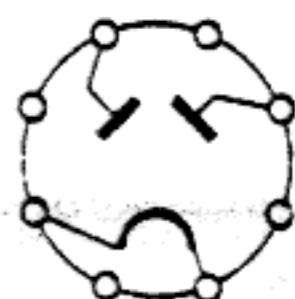
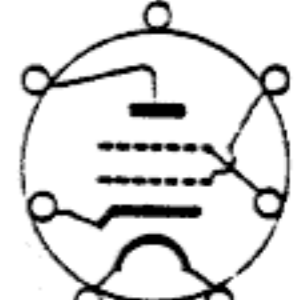
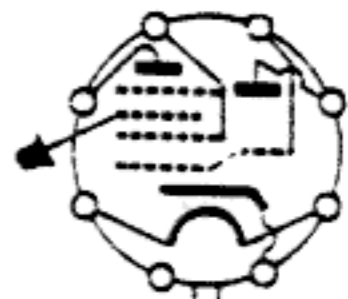
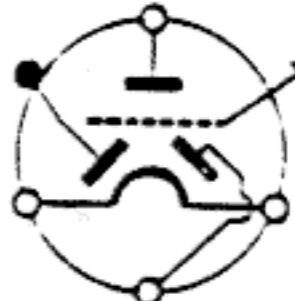
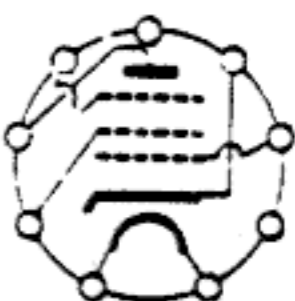
<i>Valve Type</i>	<i>Set up Number</i>									<i>Base Diagram</i>
1. Osram MH4 indirectly heated triode. British 5-pin base.	6	4	2	3	1	0	0	0	0	
2. Osram U50 full wave rectifier directly heated. Octal base.	0	2	0	8	0	9	0	3	0	
3. Mullard PenA4 indirectly heated output pentode. British 7 pin base.	0	4	5	2	3	1	6	0	0	
4. American 6K8 indirectly heated frequency changer. Octal base.	0	2	7	5	4	6	3	1	0	
5. Mullard TDD2A battery double diode triode. British 5-pin base.	6	8	2	3	9	0	0	0	0	
6. Mullard EF50 indirectly heated HF pentode. B9G base.	2	5	6	1	0	1	4	0	3	

Provision for New Valve Bases

To cover the possibility of the introduction of new valve bases not provided for on the standard panel and also the introduction of valves which may necessitate special conditions associated with standard valve holders, a plug-in adaptor is available which enables many non-standard valve holders to be combined in this adaptor and plugged into the octal or other suitable base on the Valve Characteristic Panel. These adaptors are available for bases not included on the Valve Panel, and also with a blank valve holder mounting panel in which can be mounted the user's own valve holder if he requires any special arrangement for which we have not catered.

The Prevention of Self Oscillation of valves under test

It will be realised that the length of wiring and its associated capacity, connected to the grid and anode pins of any one of the valve holders, can constitute a tuned line corresponding to a high resonant frequency often of the order of 100 megacycles per second or higher. A number of modern valves have sufficiently high slope to overcome the inherent losses associated with such a tuned line, and are, therefore, capable of bursting into oscillation at a frequency determined by the constants of their associated valve holder wiring when being tested at or near their maximum working slope. It is quite obvious that in order to test a valve some wiring must exist between the valve holder and test circuit. Further, since a multiple test panel is desirable to obviate the necessity of a vast number of separate plug-in units, the total amount of wiring associated with any one valve holder must be a considerable number of inches in length. It is almost impossible to increase the effective resonant frequency of the lines thus produced to such a high value that no normal valve will oscillate therewith. The only alternative is to render the line of comparatively high loss and in extreme cases to stopper the valve in question right on top of its anode and/or grid connection. Unfortunately, however, since a very large number of pin combinations have to be accommodated in any one valve holder the presence of such a resistance in say a heater or cathode circuit could give completely erroneous results, and this stoppering system could therefore only be very sparsely used.

The problem of self oscillation has been almost completely eliminated in the "AVO" Valve Characteristic Meter Mark IV, by wiring the Valve Holder Panel in connection loops of predetermined lengths, so that any valve inserted would tend to oscillate at a definite frequency dependent on the loop lengths. These separate inter-connection loops are then loaded with ferrox cube beads so that oscillation cannot occur when testing valves with conventional characteristics, irrespective of the Valve Holder and pin combination used.

In certain circumstances where a newly introduced valve of high efficiency is likely to be tested in any quantity and shows signs of oscillation, the separate valve holder adaptor can be employed with considerable advantage. By this means a valve holder can be stoppered to the maximum extent necessary for the valve in question without references to any other valves that may be incorporated therein, for when other types of valve are likely to be used, the adaptor can be set aside and the valve panel used normally. It must be stressed that this oscillation is unlikely to occur where the valve is tested at anode currents lower than normal, or at a point on its curve which renders its mutual conductance low. Were a purely empirical method of testing employed in the Valve Characteristic Meter, therefore, the problem would in all probability not arise, but since every effort has been made to actually test the valve under its correct operating conditions of current and voltage, then it is on this account working at its normal efficiency and can, unless special precautions are taken, give rise to the oscillation troubles to which we have referred.

DIAGRAM OF STANDARD PIN CONNECTIONS

(viewed from the reverse side of base)

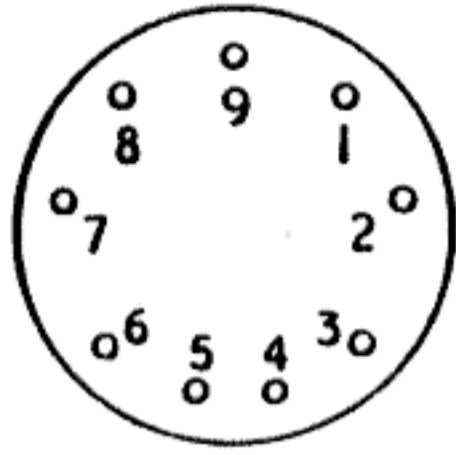

BRITISH NINE PIN (B9)

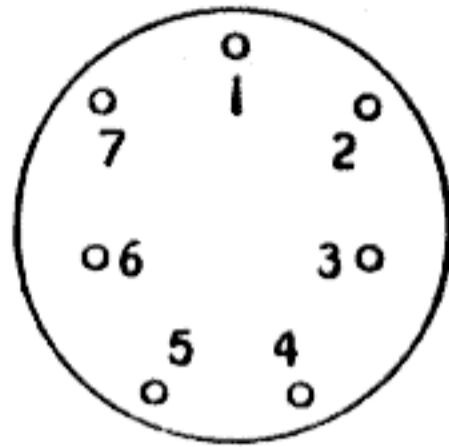

BRITISH SEVEN PIN (B7)

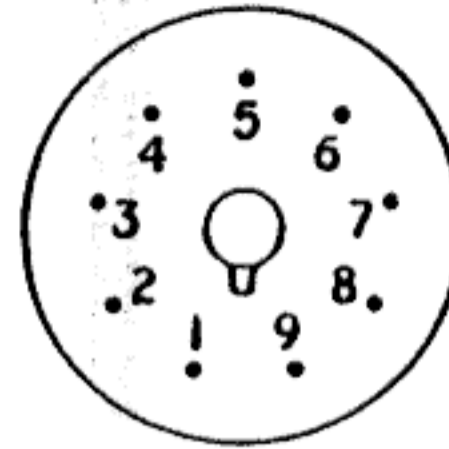

B9G

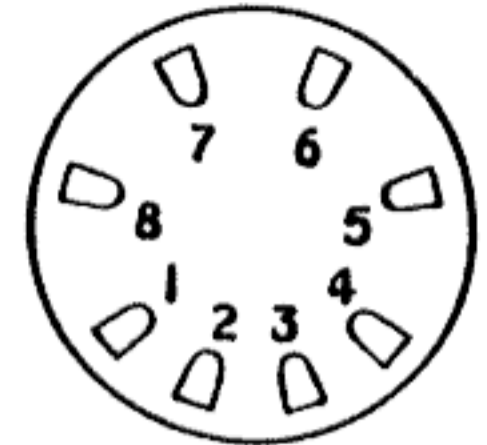

'P' TYPE BASE (B5C)

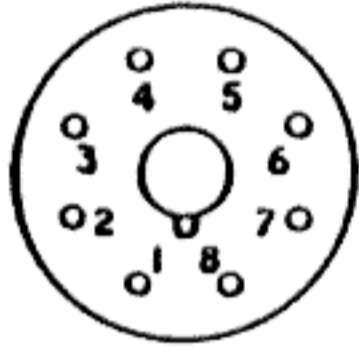

INTERNATIONAL OCTAL (AO8)

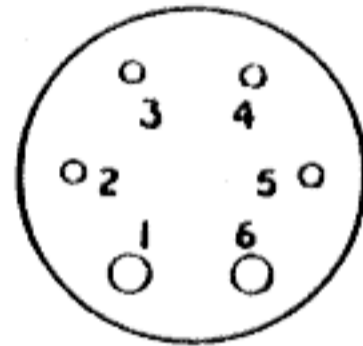

AMERICAN SIX PIN (UX6)

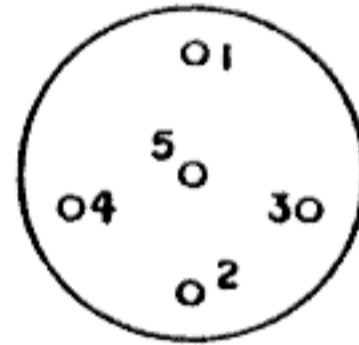

BRITISH 4/5 PIN (B5 & B4)

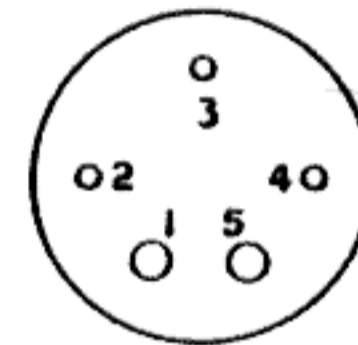

AMERICAN FIVE PIN (UX5)

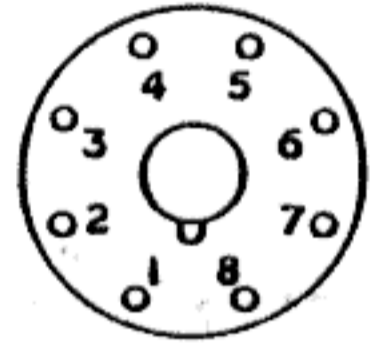

MAZDA OCTAL (MO8)

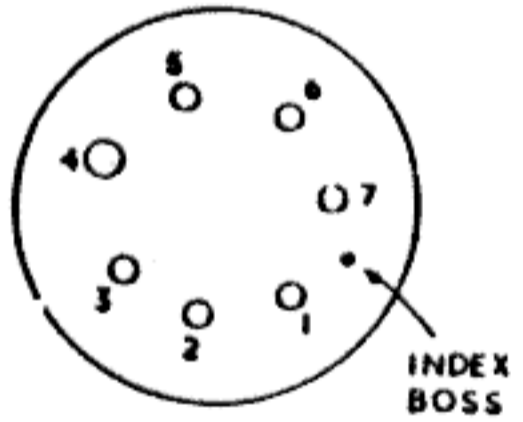

B7A

INDEX BOSS

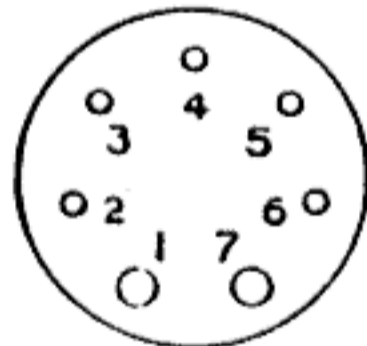

AMERICAN SMALL SEVEN PIN (SM7)

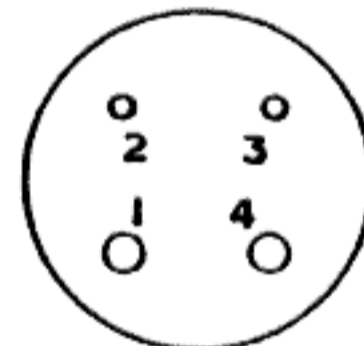

AMERICAN FOUR PIN (UX4)

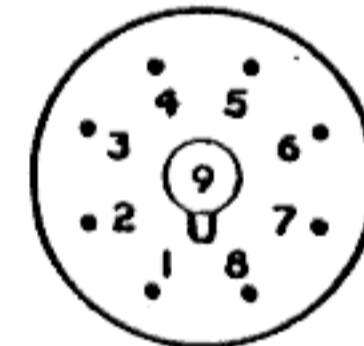

AMERICAN OCTAL (B8B or B8G)



SUB MINIATURE 8 PIN (B8D)

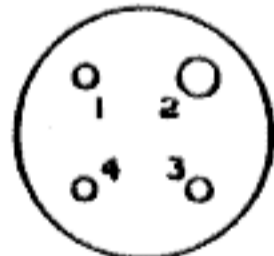

HIVAC FOUR PIN (SM4)

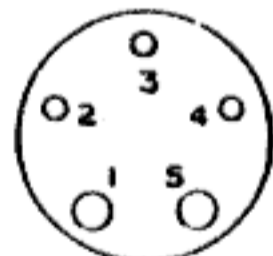

HIVAC FIVE PIN (SM5)

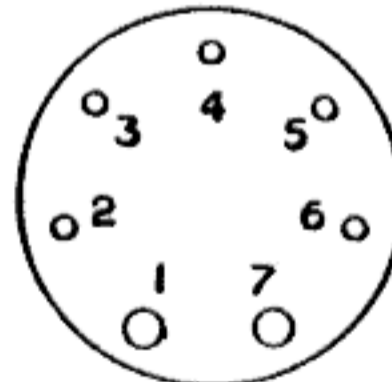

AMERICAN SEVEN PIN (UX7)

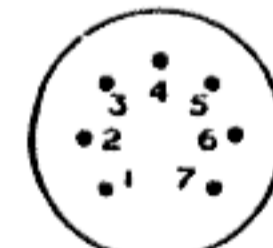

B7G

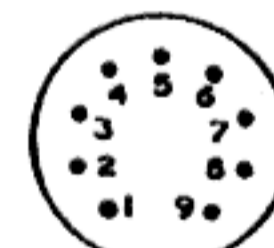

B9A



B3G

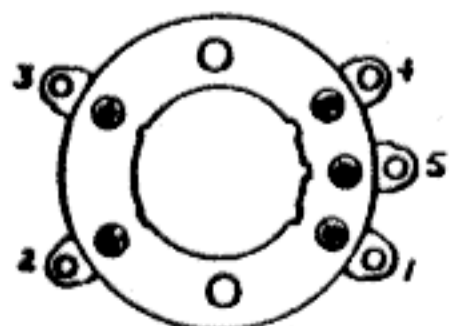

SAA & 7AA
(ACORN VALVES)

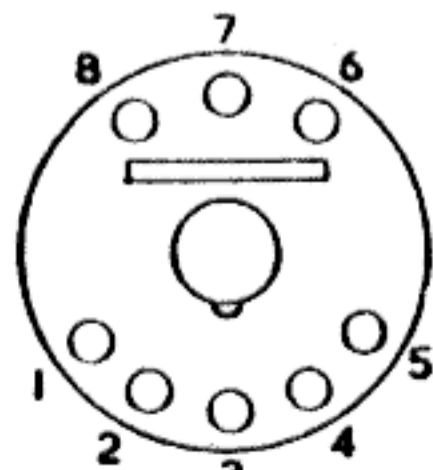

FB



B8A

COLOURED SPOT

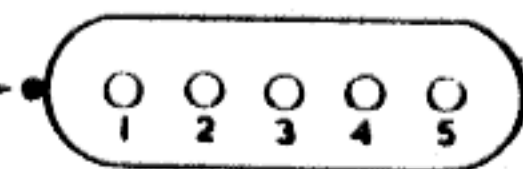

B5A



B5B

Whilst discussing the problem of oscillation, mention should be made of the rectifier (which will be seen in the circuit diagram) included in the screen circuit of pentode and tetrode valves. This rectifier has been incorporated to obviate a difficulty which can arise in certain circumstances when testing valves of the beam tetrode type with alternating current applied to their electrodes. As the applied electrode voltages approach zero during a portion of their operative cycle, the focusing of the beam of such valves is to some extent upset and the result can be that the screen circuit begins to show an emission in a reverse direction to normal screen current, with the result that the anode current rises and the current taken by the screen decreases rapidly and becomes negative. This can cause screen overheating and besides giving an unstable and erroneous impression of the condition of the valve, can, if allowed to continue, damage the valve. To obviate this condition, therefore, the rectifier is included in such a manner that only its low forward resistance is presented to the screen passing current in the normal direction, thus causing a negligible variation to standard conditions, but the reverse resistance of the rectifier is operative to limit screen current of the opposite direction to negligible proportions and thus prevent the conditions stated above, from coming into effect.

Procedure for Valves having Internally Connected Pins

On certain valves of recent manufacture, particularly the miniature glass type employing B7G, B8A, B9A, etc. bases, it has become the practice of manufacturers to connect internally, certain of the valve electrodes to pins which would otherwise be blank and free from any connection. Although the manufacturers specify the pins on which this is likely to occur they reserve the right to vary the nature of the internal connections from time to time as prevailing conditions might demand. This in itself prevents the inclusion of the electrode thus internally connected, in the normal selector switch set-up of the valve.

Valves with internally connected pins present no difficulty when tested on the valve characteristic meter Mk. IV but because the valve data manual is used with earlier instruments, internally connected valve pins are marked (*) in the **Roller Selector Switch** number column. When using the valve characteristic meter Mk. IV, where the asterisk appears in the **Roller Selector Switch** number denoting an internal connection, the appropriate roller should be set 0, e.g. U81, where the roller selector switch number reads **9 **8 230. set roller selector switch to read 009 008 230 and follow the normal procedure.

THE CONTROLS ON THE FRONT PANEL THEIR FUNCTIONS AND OPERATIONS

All the controls necessary for carrying out the essential valve testing functions are situated on the front panel of the instrument, and by the manipulation of these controls and the use of the valve panel already described, the following tests can be undertaken.

1. The direct indication of insulation resistance between specific electrodes with the valve cold. This test will also indicate heater continuity.
2. The direct indication of insulation resistance between electrodes with the valve filament hot, including a separate test for the important function of cathode to heater insulation.
3. The measurement of mutual conductance directly in milliamps/volt over a full range of applied high tension and bias voltages.
4. The comparative indication of valve goodness on a coloured scale on the basis of mutual conductance reading.

5. The ability to plot complete sets of mutual characteristics I_a/V_{g1} , I_a/V_a , I_s/V_{g1} , I_s/V_s , etc., with a complete range of applied electrode voltages corresponding to D.C. operating conditions.
6. The testing of rectifiers under reservoir condenser conditions with a full range of D.C. loading.
7. The testing of signal diodes under suitable D.C. load.
8. The testing of the separate sections of multiple valves, the non-operative section of the valve being maintained at reasonable working electrode voltages.
9. The indication of grid current and valve softness, directly on meter scale.
10. The anode current can, if desired, be read on an external meter of greater sensitivity and tests carried out on valves which require an anode load.

The separate functions of the controls available are as follows:—

The Set ~ Control

This control enables minor adjustments to be made to the input tapplings on the mains transformer after the coarse mains tapping has been set.

The Leakage Switch

This switch serves the dual purpose of putting the instrument in a condition for the initial setting of the Set ~ control and also indicates the electrodes, if any, between which leakage occurs with the valve in a cold condition. It also serves to indicate heater continuity.

The Circuit Selector Switch

This is a five position switch enabling the instrument to be set up in readiness for the type of test to be undertaken. All the necessary internal circuit connections are made to satisfy the test conditions required, whilst internal test circuits, not required, are automatically removed from the valve.

On position **Check (C)** the instrument is set up for the initial mains voltage adjustment, and is suitably connected for the cold electrode leakage test.

At the **Check (H)** position of the switch, the valve is automatically tested for electrode leakage, with the heater hot, between the cathode and heater, and all other electrodes strapped.

At position **C/H. INS** the valve is automatically tested for cathode to heater insulation with the valve hot.

With the circuit selector turned to **Test** all normal mutual characteristics are measured in conjunction with the electrode voltage switches and other relevant controls. It will be noted that in the case of the insulation tests the meter is automatically shunted to the appropriate sensitivity and the insulation scale can be read directly. On the **Test** position of the **Circuit Selector** switch, however, the **Meter Switch** is brought into circuit, thus enabling the meter range to be suited to the current measurement to be undertaken.

Also at this setting in conjunction with the D_1 and D_2 positions of the **Electrode Selector** switch and the appropriate scale of the **Meter Switch**, signal diodes and rectifying valves can be checked. At the position **gas**, the meter is connected in series with the grid, and gives direct indication of any gas current flowing.

The Anode and Screen Voltage Switches

As their names imply these switches enable the requisite electrode voltages to be applied to screens and anodes of valves for the purpose of carrying out mutual characteristic measurements. They are calibrated in the equivalent DC voltage settings and, therefore, no account need be taken of the actual value of AC voltage which appears at the electrodes of the valve, which, as already explained, will differ from the equivalent DC value marked at the switch position.

The A₁A₂ normal/unlimited switch

When testing valves having dissimilar double electrode assemblies it is necessary to limit the anode voltage on the section not under test. The A₁A₂ normal position on this control in conjunction with the electrode selector switch, provides the facility for inserting a suitable limiting resistor in the appropriate anode circuit. Thus when testing double valves (triode hexodes, triode pentodes etc.) this control is switched to the A₁A₂ Normal position. For single and double valves having identical sections, this control is switched to the Unlimited position. The control is inoperative when testing diodes, rectifiers, etc.

The Heater Voltage Switches

This dual switch combination is for adjustment of the heater voltage applied to the valve under test. To enable a very wide range of heater voltages to be obtained the settings of the two switches are arranged to be additive. Thus, with the left hand switch set at 0 all useful voltages between 0.625 and 7.5 can be applied to the valve by the right hand switch, whilst with the left hand switch at any figure above 0 the value indicated on the left hand switch should be added to the indication of the right hand switch. For example, with the right hand switch set at 5 and the left hand switch at 80, the heater voltage applied to the valve will be 85.

The Negative Grid Volts control

The negative grid volts control comprises two sections.

- (a) A continuously variable control calibrated 0—5, 0—20 (the selection being determined by the position of the grid volt switch).
- (b) A nine position grid volts switch giving steps of 0, 5, 10, 15, and 20 volts, the remaining positions giving voltage steps of 20 volts.

This arrangement enables any bias voltage down to —100 to be applied to the valve, the incremental steps being additive to the setting of the variable control.

The Backing Off Controls enables the initial anode current reading for the valve to be neutralised prior to the taking of mutual conductance readings. Two variable controls are used for this purpose, one fine and one coarse, which provide smooth backing off control to a maximum of 100mA. The rotation of the controls in an anti-clockwise direction will cause the meter needle to approach zero. For normal characteristic tests, both controls should initially be set fully clockwise.

The Meter Switch is a combination switch to shunt the meter suitably to the current measurement to be undertaken and also to insert the right value of load when making tests on rectifiers and diodes. It has two calibration scales. The left hand scale marked Ia, with switch positions 2.5, 10, 25 and 100, is used with the Circuit Selector at position "test" and the Electrode Selector at the position A1, A2 or S to indicate the full scale deflection of the meter in mA when measuring anode or screen current. The position mA/V after having the "backed off" standing anode current is used in conjunction with the Set mA/V Control for the measurement of mutual conductance either direct or by the comparison method using the coloured scale on the meter.

The right hand scale marked D/R with switch positions 1, 5, 15, 30, 60, 120 and 180 represents the load current when making diode or rectifier tests with the **Electrode Selector** at D1 or D2. Thus if the valve is rated at say 60 mA per anode, the **Meter Selector Switch** should be turned to "60" on the D/R scale and the comparative goodness of the valve with reference to this basic figure will be shown on the coloured scale.

The Set mA/V Control. This control has two scales 1—10 and 8—60 selected by means of an associated rotary switch. When the control is set to the expected mutual conductance figure for the valve under test, the standing anode current backed-off to zero and the **Meter Switch** set to mA/V, the meter shows the relative goodness of the valve under test. If required the actual mutual conductance of the valve can now be obtained by rotating the set mA/V Control until the meter needle covers the calibration point at the centre of the "good" portion of the scale (marked 1 mA/V) the mutual conductance of the valve can now be read directly from the **Set mA/V Control**.

The Electrode Selector Switch marked D₂, D₁, A₁, A₂ and S enables separate tests to be made on multiple valves, and also makes possible the taking of Screen (or g₁) characteristics. With this switch turned to "A₁", the figures of anode current and mutual conductance shown on the meter are relevant to the anode designated on the set-up roller by $\frac{6}{A}$. As such the switch is in position for measurements on all single electrode system valves (triodes, pentodes, etc.). This position also serves for the first half of double valves (double triodes etc.) and for the triode or pentode section of multiple diode valves (double-diode-triode, etc.) The same setting of this switch serves for the triode or oscillator section of frequency changers.

With the **Electrode Selector Switch** at position "A₂" and the A₁A₂ normal/unlimited switch set to its appropriate position, the indicator meter will show anode current and mutual conductance associated with the second anode of double valves, the mixer anode of frequency changers and all anode systems associated with the set up figure $\frac{7}{A_2}$. In this condition the first anode is not left floating, but has the normal anode volts supplied to it via a limiting resistance of 24K Ω .

With the electrode selector set to 'S' the current meter is inserted in the screen (g₂) circuit of the valve, the screen current will thus be indicated. When making this test, the anode voltage is automatically applied to all the anodes within the valve. **Note:** that in the case of double pentode valves, the screen current indicated will be the combined current of both sections, it should also be noted that the A₁A₂ normal/unlimited switch **must** be in the A₁A₂ normal position for triode hexode and triode pentodes etc. and in the **unlimited position for pentodes and tetrodes (both single and double), hexodes, octodes etc.**

With the **Electrode Selector** at position D1, the indicating meter is associated with the diode anode of a signal diode or rectifying valve (and the first anode of double diode and full wave rectifiers). This switch position is directly associated with the anode designated on the selector switch roller by $\frac{8}{D_1}$.

With the **Electrode Selector** at position D2 the indicating meter is associated with the second anode of double diodes and full-wave rectifiers. In this case the switch position is associated with the roller switch setting $\frac{9}{D_2}$.

Heater current measurement

This test is particularly useful on series operated valves where heater current is more important than heater voltage. By removing the left side plate, the heater current link will be exposed, by disconnecting this link and substituting a pair of leads connected to a suitable ammeter, the operating heater current can thus be monitored.

Mains Voltage control and fuse link

By removing the left hand side plate of the instrument, the coarse voltage control will be exposed. The instrument can then be set to any of the following voltages: 110/128, 190/210, 210/230, 230/250, 50/60 c/s the setting being made by means of the fuse link which is rated at 3 amps.

GENERAL PROCEDURE FOR TESTING A VALVE

1. After having set the coarse mains voltage tap at the side of the instrument to suit the supply voltage, connect mains lead to supply noting that red and black leads are live and neutral. The green or yellow lead is the Earth connection. Switch on and the indicator lamp should light up.

2. Turn the **Circuit Selector** switch to position **Check (C)** and **Leakage** switch to position " \sim ". The instrument needle should now rise and assume a position near the black region of the insulation scale denoting zero ohms. Rotate the **Set \sim** control until the meter needle assumes its nearest point to the red line in the middle of this black scale marking. With a correct setting of the initial mains voltage adjustment rotation of the **Set \sim** control should enable the needle to be moved on either side of the red line. If this is not the case and rotation of the **Set \sim** control does not enable the needle to reach its setting mark from either direction, then the initial mains setting should be moved to the next appropriate tapping. This tapping should be higher than the one chosen if the needle always appears to the right of the red mark and lower if to the left. When making insulation measurements it should be noted that the insulation voltage is 100V (mean) provided by a full wave rectifier circuit, therefore insulation measurements should only be made on valves having insulation ratings greater than 150V.

3. Having set up the accuracy of the instrument to conform to the applied mains voltage, refer to the "AVO" Valve Data Manual, or alternatively to the maker's characteristic data for the valve and set up the appropriate valve holder connections on the Valve Panel selector switch as already explained.

Set the **Heater Voltage Switches** to their correct value for the valve and insert it in the appropriate valve holder (NOTE-Heater voltages in parenthesis should be ignored as they relate to valve tester Type 160 ONLY), without moving the **Circuit Selector** switch from its position **Check (C)**. Rotate the **Leakage** switch through its various electrode positions starting with the extreme counter clockwise position marked "H". At position "H" the meter should show a short, thus indicating heater continuity. Thereafter any reading obtained on the insulation scale of the meter will show an electrode insulation breakdown corresponding to the electrode indicated by the **Leakage** switch setting. (Thus a reading on the meter of 1 megohm when the **Leakage** switch is set to position "G₁" and position "S" will indicate that a cold insulation breakdown of 1 megohm is occurring between the grid and screen electrodes of the valve.) It will be noted that wherever electrode leakage occurs, indication of this will be shown at two positions of the **Leakage** switch, because, obviously, leakage must occur between two points. In the case of breakdown to heater from any other electrode, such leakage indication will only occur at one switch setting subsequent to the initial selector setting, which should automatically show zero ohms to denote heater continuity.

4. Having ensured that no cold leakage path of any magnitude is present in the valve to be tested turn the **Circuit Selector** switch to **Check (H)**. Allow a few moments for the

valve heater to warm up and note whether any meter deflection occurs. Such a deflection would denote in megohms the amount of insulation breakdown that occurs between cathode and heater strapped and all other electrodes of the valve when heater voltage is applied. Note that if, for any reason, the **Circuit Selector** switch is turned back to **Check (C)** there will, in all probability, be an indication of an apparent cold electrode insulation breakdown between a number of the valve electrodes. This need not be the cause and the reading will be found generally to disappear after a few moments. The reason for such an indication is obvious when it is realised that the valve cathode has been heated during the **Check (H)** test. When returning to the **Check (C)** position, therefore, the cathode is hot and still emitting. What appears to be a temporary electrode breakdown, therefore, is in fact the indication of emission which disappears as the heater or cathode cools.

5. Turn **Circuit Selector** switch to **C/H. INS** when any cathode to heater insulation breakdown which occurs with the heater hot will be shown on the insulation resistance scale of the meter. No set rule for the rejection of a valve on this score can be laid down, but it will be realised that in many circuits where an appreciable potential exists between heater and cathode such as, for instance, in cathode follower circuits or DC valve amplifiers, the presence of a heater to cathode breakdown of the order of megohms can often give rise to quite serious trouble. Heater to cathode insulation breakdown, either permanent or variable, can also give rise to noise in valve amplifier circuits. If, on the other hand, the value of cathode to heater circuit resistance is only of the order of a few hundred ohms, as for instance where cathode biasing is used with high slope valves, then a cathode to heater insulation breakdown of the order of fractions of a megohm need not give rise to any serious trouble.

6. Set the A_1A_2 normal/unlimited switch to the appropriate position for the valve under test.

7. The next test normally to be made upon the valves is the measurement of some or all of its mutual characteristics. This may take the form of the complete plotting of one or all of its characteristics, or the measurement of its mutual conductance, or the comparative testing of the valve on the basis of its mutual conductance. All these require the manipulation of the main voltage and meter controls and, before such a test is undertaken and the **Circuit Selector** switch turned to position **Test**, one should be assured that all the requisite controls are correctly set. This applies to the setting of the anode, screen and grid voltage controls, the **Meter Switch** and the **Electrode Selector** switch. *In particular, where the probable anode current of the valve is unknown, the **Meter Switch** should be set to 100mA to avoid damage to the movement if the current flowing is such as to be considerably higher than that catered for by the lower meter range positions.* It is always perfectly simple and safe to set the **Meter Switch** at successively lower full scale current deflections to cater for a valve, the anode current of which is less than that which can be appropriately read on a higher range. If the reverse procedure is adopted, however, then it is quite possible that a damaging current may have passed through the meter circuit before the latter is set to a suitable high range. The procedure for taking the necessary valve measurements is then almost self explanatory.

Where only a measurement of mutual conductance is required then the data for this can be taken from the "AVO" Valve Data Manual. The electrode voltage settings should be made as indicated and consequent upon such settings an initial anode current will be shown on the meter which has been finally set to a suitable range. This anode current reading should normally be compared with the anode current reading shown in the tables, as it will give an initial indication of the valve's "goodness." Quite obviously if a valve

shows an anode current reading considerably below that which is appropriate for the applied electrode voltages, then its emission is much lower than would normally be expected and in normal circumstances the valve will not function at full efficiency. More particularly does this apply in the case of valves used either as oscillators or output valves, for in both conditions the valve has to deliver an appreciable power which cannot obviously be up to standard if the emission is low. At the same time care should be taken not to jump to false conclusions on this basis when testing valves of very high slope and short grid base, where it may be possible to double the valve anode current for a change in bias of some .25V, and a very slight variation in the valve characteristics may give rise to an erroneous impression of the valve's "goodness" on the score of anode current.

8. After having observed the initial anode current reading and obtained therefrom such information as is desirable, this anode current indication may now be backed off to zero by the **Backing Off** controls and the **Meter Switch** Set to its 2.5 position, any further adjustment to zero being made by the **Fine Backing off Control**.

The **Set mA/V Control** should already have been set to the value given in the valve data and it would be as well to explain here how the two scales on this control should be employed. The inner scale marked 1—10 applies a potential to the grid such, that at the slope indicated the rise in anode current is 1mA. Thus when the **Set mA/V** dial indicates 1 mA per volt, the bias change is equivalent to 1V, but when the control is set at 10 mA per volt the bias change is only 1/10th of a volt.

The outer scale marked 8—60 applies a potential to the grid such that at the slope indicated the rise in anode current is 3mA. It therefore follows that for a slope of 60 mA/V on this scale the voltage change at the grid will be 50mV.

To measure the comparative "goodness" of a valve in terms of mA/V, with the anode current backed off to zero as already explained, any final adjustment having been made with the **Meter Switch** at its 2.5 mA position, set **Meter Switch** to position mA/V. The comparative "goodness" of the valve will now be given on the **Replace/Good** scale.

All valves coming within the green portion can be taken as satisfactory. Valves in the red portion are suitable for rejection, whilst the small intermediate band between the green and red portions denotes a valve which, whilst not entirely unsatisfactory, is not by any means working at its full rated efficiency. Subsequent action on the valves whose test figures come within this band will obviously have to be related to the particular requirement of the moment.

Alternatively, where it is required to obtain a reading of mutual conductance, and not merely a gauge of the valve's "goodness" factor on the basis of mutual conductance, then after backing off to zero, the **Meter Switch** should be set to position mA/V and the **Set mA/V** control rotated until the meter needle covers the calibration line at the centre of the good scale (marked mA/V). The mutual conductance of the valve may now be read from the **Set mA/V Control**.

Valves having a slope of less than 1mA/V cannot be checked by the comparative "goodness" method (using replace/good scale). In such instances, the set mA/V control should be set to position 1, the standing anode current backed off, and the **Meter Switch** set to position mA/V. The mutual conductance (slope) of the valve will now be directly indicated on the meter (using scale marked 0.1—1 mA/V).

Where more comprehensive tests of the valve are required, to assist in the solution of development or more intricate test problems, the plotting of one or a family of mutual characteristics can often give a much more complete answer. This may readily be undertaken with the **Valve Characteristic Meter** and is performed with the **Circuit Selector** in its position **Test**. The manipulation of the controls subsequent to the obtaining of the initial anode current readings is not of course required, it being merely necessary to plot the value of the appropriate electrode currents as read from the meter, against the settings of the associated electrode voltage switches. I_a/V_{g_1} curves will be taken at a pre-determined setting of anode and/or screen volts, the reading of the anode current obtained being plotted against the settings on the variable grid bias controls. Similarly I_a/V_a curves will require a fixed setting of grid bias, anode current being plotted against the settings of the anode voltage switch.

Where either mutual conductance or characteristic curves are required for the screen (g_s) of the valve in question, then the **Electrode Selector** switch should be set to position "S," the $A_1 A_2$ normal/unlimited switch should be set to the appropriate position depending on the type of valve under test. The meter current shown will be an indication of the screen (g_s) current and all the above instructions can be related thereto.

Remarks in relation to the tests described above as applied to multiple or special types of valve, will be found in subsequent test notes.

9. Where a valve is suspected of passing too much grid current, a measure of the magnitude of grid current at the desired conditions of applied electrode voltage may be made after having measured the mutual conductance of the valve in question. With the **Meter Switch** set to 100 mA on the I_a scale and the **Circuit Selector** turned to position **Gas** the meter is now directly connected in the grid circuit of the valve under test and gives a direct indication of grid current flowing.

10. The testing of rectifying valves should really be associated with the requirements of the circuit in which these valves are to work, although in most cases, in the data for the valve in question a figure is quoted denoting the standard emission to be expected for a valve of the type under test.

The procedure for carrying out the test is again straightforward. All initial tests should have been carried out as for amplifying valves, but before setting the **Circuit Selector** to **Test**, the suggested load current figure for the valve given in the Data Manual should be set on the **D/R** scale of the **Meter Switch**. This load current, it will be realised, applies to one anode only. The setting of load current can either be determined from the tabulated data as already mentioned, or alternatively can be related to the total current that the valve is required to deliver. Thus in a piece of apparatus where the total HT current drawn is say 50mA, then a rectifier load current setting of "60" will be an adequate test for the valve emission (assuming half wave rectification). Alternatively, if the valve is a new one, the maker's rating for maximum load current can be used as the basis for the setting of the **Meter Switch**. It will be realised that since each half of a full wave rectifier is tested independently, then the setting of the range switch should indicate half the total value of current that the valve would be expected to deliver in a full wave circuit. For instance a valve rated at a maximum current of 120 mA would be tested with each anode at the "60" position on the **Meter Switch**.

No further manipulation of the electrode voltage controls is required. The heater voltage is already set whilst anode, grid and screen voltage controls are completely dissociated from the test circuit by the setting of the **Electrode Selector** switch to **D1** or **D2**, all appropriate voltage and circuit connections also being automatically made. Having,

therefore, correctly set up the valve as explained, the indication of the meter needle on the coloured scale will show the operative goodness of the valve in relation to the standard load current chosen.

Similar remarks apply to the testing of signal diode valves, with the exception that these are always tested with the **Meter Switch** at " 1 " unless otherwise specified.

INSTRUCTIONS FOR TESTING SPECIFIC VALVE TYPES

The function of a valve, as distinct from its manufacturer's type number is indicated by a symbol in the form of letters appearing at the extreme right of the test data; thus a half wave rectifier would have the letter " R " in the function column, whilst a full wave rectifier would be designated by " RR ". Similarly, diode valves will be shown by the letter " D " the number of diode elements being indicated by the number of " Ds ", thus " DDD " refer to a triple diode.

The testing of *multiple diodes or rectifiers* is carried out in the manner already explained, the **Electrode Selector** switch being used to select the diode or rectifier element, the comparative emission for which, being indicated on the meter. It will be realised that when dealing with diodes or rectifiers **D1** and **D2** positions of the selector switch represent diode or rectifier anodes 1 and 2 respectively and correspond to figures 8 and 9 in the set up figure.

In the case of **triple diodes** since only two anode systems are normally catered for, a special procedure is adopted in the set up figure. At the position in the set up number representing the third diode the symbol † is included, the first and second diodes being indicated by 8 and 9 respectively in the normal way. The valve should now be tested normally with the selector switch set to 0 where the † appears in the set up number. This will give emission figures for diodes 1 and 2. Now rotate the **Selector Switch** rollers so that the two rollers originally set at 8 and 9 are now set to 0 and set up the position † as 8 on the selector switch. A further test with the **Electrode Selector** switch at **D1** will thus give the emission of the third diode, e.g., AAB1 will be indicated in the data as 0231†0980. To test diodes 1 and 2 the set up on the roller switch will be 023100980 and diodes 1 and 2 will be tested in the normal manner. For obtaining the emission figure for the third diode the **Selector Switch** will be altered to 023180000 and the **Electrode Selector** to position **D1**.

Combined Diode and Amplifying Valves will be represented in the type columns by " DT " and " DDT " for diode triodes and double diode triodes, whilst " DP " and " DDP " indicate diode pentodes and double diode pentodes. The testing of such valves is automatic, the amplifying section being tested first with the **Circuit Selector** switch at position **Test** and the **Anode Selector** at position " A₁ " whilst the rotation of the **Meter Switch** to the appropriate load setting and the **Electrode Selector** to " D1 " and/or " D2 " would cause the meter to indicate the comparative goodness of the valve. (Unless otherwise stated the load setting will be position 1 on the D/R scale of the **Meter Switch**.)

Double Triodes, Double Pentodes or Double Tetrodes will be indicated by the letters " TT " or " PP " in the type column and will be tested in the normal way for each half of the valve, selection being made by the rotation of the **Electrode Selector** switch to A₁ or A₂ corresponding to set up figures 6 and 7. The A₁A₂ normal/unlimited switch should be set to the appropriate position. Note that screen current readings obtained whilst checking double tetrodes or double pentodes will be a combined value for both halves of the valve.

Frequency Changers of the Heptode, Hexode class employing the normal oscillator section as a phantom cathode for the mixer section are not very satisfactorily tested in two sections, as the nature of the valve construction is such that each section is dependent on the other for its correct operation. For test purposes therefore, this valve is shown connected as a triode or pentode for which, where possible, anode current and/or mutual conductance figures are given. Such valves are indicated by the letters "H" in the type column. **Note:** the A_1A_2 normal/unlimited switch should be set to the unlimited position.

Frequency changers of the **Octode** class designated by "0" in the type column are, as will be seen from the data, tested as if they had two separate electrode assemblies, separate data being given for each. In this case the oscillator section is tested with the **Electrode Selector** at A_1 and the mixer section at A_2 .

As a further test to ensure the probability of such a valve oscillating satisfactorily, an indication of failing emission will possibly give the most useful results. It will be realised that when a valve is up to standard its cathode will develop its full emission at the rated heater voltage for the valve, and any slight change in the cathode temperature will not result in a corresponding change in the emission. If, however, the cathode's emission is failing, then an increase or decrease in the cathode temperature will result in a noticeable change in the emission for the valve. When a valve is oscillating it tends to run into the positive grid region, and thus makes use of the full emission capabilities of the cathode. Any failing emission will limit its utility in this respect. As a subsequent test, therefore, on a valve designed to be used as an oscillator, it is helpful to note the anode current at the rated test figures with the normal heater voltage applied and then decrease the heater voltage by about 10 to 15% (the next tapping on the heater switch) for a short period. In the case of a valve with failing emission this will result in a decrease in the anode current considerably greater than the percentage decrease in heater volts. Such a result would suggest that the valve will not oscillate very satisfactorily. A negligible or small percentage decrease in anode current (or of the same order as the heater volts change) will show that the valve is developing its full emission at the rated heater voltage, and provided that the circuit conditions are correct it should oscillate normally.

Frequency Changers employing separate electrodes assemblies for oscillator and mixer functions are designated by "TH" (Triode Hexode) "TP" (Triode Pentode). The separate sections of this type of valve are not interdependent, as in the case of the phantom cathode types, and they can thus be tested in two separate sections as triode and pentode respectively. This arrangement is catered for in the set up figures given, 6 corresponding to the triode section and tested with the **Electrode Selector** at A_1 whilst 7 in the set up figure corresponds to the mixer section which is tested with the **Electrode Selector** at A_2 . The figures to be expected from both halves of the valve are given in the tables where available, but it is often informative to apply a test for failing cathode emission to the triode or oscillator section in the manner already described. The A_1A_2 normal/unlimited switch should be set to the A_1A_2 normal position.

In the case of normal triodes and pentodes (including beam tetrodes) the test procedure for which has already been fully outlined, the type column will show the symbol "T" and "P" respectively.

THE USE OF THE LINKS ON THE VALVE PANEL OF THE INSTRUMENT

These links enable a load to be inserted into either anode circuit of the valve under test when an anode current or mutual conductance test is being undertaken on the electrode circuit in question. They therefore enable dynamic figures for the valve or electrode

system concerned to be obtained, the procedure being to disconnect the shorting link and to connect across the terminals a resistance or other load which it is desired to include in circuit. When checking any of the following types, the A_1A_2 normal/unlimited switch should be set to unlimited.

Tuning indicators (Magic Eyes) are tested with the controls set according to the figures given in the separate data table, using the screen switch for obtaining target voltage and inserting the anode load, shown in column marked "Ra" by means of the link on the valve panel of the instrument. At the approximate bias given in the table the triode section should be at cut-off and the "eye" fully closed. On varying the grid bias to zero the "eye" should open fully and the value of anode current should be approximately that appearing in the table. In the case of double sensitivity indicators giving multiple images responding to different sensitivities, two sets of data (where possible) are given, the first set referring to the more sensitive indication.

Gaseous Rectifiers

These also necessitate the use of the link, as such valves would normally pass a damaging current if tested without suitable limiting load in the anode circuit. They are tested with the **Circuit Selector** switch turned to **Test**, anode voltage and representative anode current figures being given in the Valve Data columns. The value of load resistance (of suitable wattage) which must be included across the link, before the valve is tested, is shown in $K \Omega$ in the "mA/V" column (which would not normally apply to a rectifier valve).

Full wave examples of this class of valve are of course tested at **Electrode Selector** switch positions A_1 and A_2 and the appropriate load connected across each link on the top panel of the instrument.

Cold Cathode Rectifiers designated by the symbol "CCR" can be tested in a similar manner to Gaseous Rectifiers, the anode voltage, approximate anode current, and load resistance being given in the data columns.

Thyratrons can be checked by comparison if set up as a normal triode, with a limiting resistance included in the link, the control ratio being indicated by a comparison between the peak value of the applied anode voltage, and the setting of the grid bias control which will prevent the valve striking and passing anode current. It must be emphasised, however, that the main value of such a test is in comparison only, as the hold off grid bias value shown on the grid bias control is only approximately half that of the bias which would normally be required to hold off the anode current of the valve at the peak anode voltage in question.

In the data columns where information is given on common thyratrons, it will be seen that this comprises a Roller Selector Switch No., Heater Voltage, Anode Voltage, expected Anode Current, and the value of the limiting resistor required. The resistor should be of suitable wattage and connected across the link terminals before the valve is inserted in its holder. Grid volts should be at their maximum setting. With the **Meter Switch** set to "100" on the I_a scale, the **Electrode Selector** at " A_1 ", and the **Circuit Selector** at **Test**, the bias on the valve should be reduced until the valve strikes and anode current flows. A good valve will pass approximately the anode current given in the Data. (If necessary, reduce setting of **Meter Switch**.) This test is suitable as an emission check on thyratrons used in television and commercial radio equipment.

Neon Indicators may be tested for striking, by setting up the roller switch so that anode and cathode pins of the tube are set 0 6 and 1 respectively, all other rollers being connected to 0. A suitable load resistance (normally between 5,000 and 15,000 ohms) should be included in the anode circuit link and the anode voltage switch should be set to a peak value as near as possible to (and in no cases lower than) the striking voltage of the neon in question. The striking of the neon will, of course, be indicated by a passage of anode current shown on the **Meter Switch** being set to " 100 " on the Ia scale. It should be noted that where the anode voltage refers to the peak applied voltage, as in the case of thyratrons and neons, the actual peak voltage applied to the valve is higher than the indication on the anode voltage switch. To obtain the peak voltage equivalent to a given setting of the anode voltage switch the figure shown on the switch should be multiplied by approximately 1.5; thus with the anode voltage switch set to represent a DC voltage of 100V the peak applied voltage is approximately 150V.

GENERAL PRECAUTIONS TO BE OBSERVED WHEN USING THE VALVE CHARACTERISTIC METER

It will be realised that when dealing with an instrument such as the Valve Characteristic Meter with such flexibility of control, it is almost impossible to protect the instrument to such an extent that the operator cannot cause damage to either the valve or the instrument by some combination or wrong setting of the controls or incorrect use of the meter. It is, therefore, important that the correct procedure, as previously outlined should be used in the sequence of the tests applied. Valves should be tested for insulation or breakdown before full voltages are applied for characteristic tests. Where any doubt whatever exists as to the probable electrode current likely to be passed, the **Meter Switch** should always be turned to its highest current range and then gradually reduced in order to facilitate reading of the electrode current.

In experimental work where a variable voltage is required to be supplied to the anode or screen electrodes of the valve, always start with the lower voltage tapplings and increase only after correct adjustments have been made to the **Meter Switch** to ensure that the meter circuit is not overloaded by an unknown current. Always make sure that the selector voltage switches have been correctly set for the valve before the instrument is switched on. In this respect it is a good practice to return the selector voltage switches to zero (particularly Heater Voltage switches) after a test has been applied and before a new valve is inserted.

Take care in setting the **Roller Selector Switch** to avoid wrongly connecting the electrodes of the valve under test. In this respect the automatic cut-out is advantageous in that it will usually save a valve if high tension voltage is inadvertently applied to the heater by incorrect setting of the switch, but it must be pointed out that after the switch is correctly set *nothing can save the heater from being burnt out if an overload heater voltage is applied by wrong setting of the heater voltage switches.*

Ensure that the A_1A_2 normal/unlimited switch is set to the correct position. Failure to observe this may result in damage to the valve under test.

Do not apply test voltages to the valve without ensuring that where necessary top cap connections have been correctly made, as a valve can often be irreparably damaged by running it with its grid or its anode wrongly connected.

Where a valve appears to be performing abnormally, as indicated for instance by a continuously rising or falling anode current which does not attain a condition of stability, do not leave the valve " cooking " for a long period to see what will ultimately happen,

as this will in all probability result in the damaging of the valve due to excessive currents in the anode or screen circuits. In general, it is not necessary or helpful to leave a valve on test for a considerably longer period than is necessary to complete the test in question.

Finally, it must be stressed that whilst every care has been taken in the compilation of this publication, the "AVO" Valve Data Manual to ensure that all data given is correct as far as is known at the time of going to press, it is not impossible that with the many thousands of figures involved, errors will have crept in. The manufacturers cannot hold themselves responsible for any damage that might occur to a valve or to the instrument from such a cause.

ABBREVIATED WORKING INSTRUCTIONS FOR THE "AVO" VALVE CHARACTERISTIC METER MARK IV

Before switching "ON" the full instruction Book should be read and always used for reference when testing unusual types of valves.

1. Check mains adjustment tap and connect mains lead to the supply, red and black leads are line and neutral, green or yellow being the earth connection.
2. Set "Circuit Selector" to "Check C" and "Electrode Selector" to "A".
3. Set "Meter Switch" to 100 on the Ia scale.
4. Turn "Backing Off" controls fully clockwise.
5. Set "Heater Volts" switches to value indicated in Valve Data. (Heater volts in parenthesis should be ignored.)
6. Set "Anode Volts", "Screen Volts" and "Grid Volts" to values indicated in Valve Data.
7. The A_1A_2 normal/unlimited switch to the appropriate position.
8. Rotate the "Set Ma/V" control to figure given in Valve Data.
9. Set "Roller Selector" switch as indicated in Valve Data and ensure that A_1 and A_2 links are tight. (For "*" in data read "0".)
10. With leakage switch at "~" switch on, and adjust pointer to position "~" by means of "Set ~" switch.

ALL VALVES

1. Insert valve, and make any top cap connections if required.
2. Fully rotate "Leakage" switch. Check heater continuity at "H" and insulation on all other positions.
3. Set "Circuit Selector" to "Check H" to measure leakage from Heater Cathode to all other electrodes strapped together with valve hot.
4. Turn "Circuit Selector" to "C/H" to measure leakage between heater and cathode with valve hot (if valve is indirectly heated.).

TRIODES, DOUBLE TRIODES, DIODE TRIODES PENTODES, DOUBLE PENTODES, DIODE PENTODES AND TETRODES IN SIMILAR COMBINATION.

ANODE CURRENT. With "Electrode Selector" at "A₁" set "Circuit Selector" to "Test". Meter should then indicate anode current. Reduce Meter Switch setting if required. *If protective relay operates, switch off and check for incorrect setting of "Roller Selector" switch or panel controls. If all controls are correct and relay continues to operate when instrument is switched on again, the valve is probably soft and the test should be discontinued.*

MUTUAL CONDUCTANCE. Reduce meter reading to zero by means of "Backing Off" controls. Set "Meter Switch" to "2.5" position and re-adjust zero if necessary. Turn "Meter Switch" to "mA/V" position, when a good valve will give an indication in the green band on the meter scale. To obtain actual mA/V reading, adjust "Set mA/V" control until needle reads on calibration point 1 mA/V, in centre of green band. The "Set mA/V" control will now indicate the mutual conductance of the valve under test.

For double valves, check data for difference in electrode voltages and repeat above operations with the "Electrode Selector" set to "A₂".

GAS TEST. To measure grid current, set "Circuit Selector" to position "Gas" and the "Meter Switch" to its 100 mA position. Meter will now indicate gas current, full-scale indication being 100 μ A.

DIODES. To check diodes turn "Electrode Selector" to "D₁" and "Meter Switch" to "1 mA" on D/R scale (unless otherwise indicated in Valve Data). Turn "Circuit Selector" to "Test". The condition of the valve will now be given on the "Replace/Good" scale. Check double diodes at D₁ and D₂ position of the "Electrode Selector".

RECTIFIERS. To check rectifiers, set "Electrode Selector" to "D₁" and set anode loading given in Valve Data, on D/R scale of "Meter Switch". Turn "Circuit Selector" to "Test". The condition of the valve will now be indicated on "Replace/Good" scale. Load reading is per anode. Check full-wave rectifiers at position "D₁" and "D₂" of "Electrode Selector" switch.

On completion of tests return all the controls to their fully clockwise position.

*** COPYRIGHT:**

No information or diagrams in whole or in part may be copied or reproduced without the prior permission in writing of AVO LIMITED.

INTRODUCTION

Throughout the past decade the Avo Valve Characteristic Meter has proved itself to be unrivalled for versatility and reliability. It is, however, inevitable that this instrument will fail from time to time and, when it does, we are anxious to ensure that it is repaired to the highest possible standard. We have, therefore, produced this schedule of spares which will form a useful guide to the trained engineer who has the task of servicing this instrument.

Procedure for ordering spare parts.

If you will kindly follow the procedure set out below, delays will not occur due to the exchange of unnecessary correspondence.

1. State the part number of the items required, also the quantity.
2. State the serial number of the instrument. This will be found on an identification label attached to the rear of the instrument.

Overseas users of our instruments should send their requirements to our Agents on their territory.

If the spares are required for use in Great Britain, application should be made direct to our Spares Department in London.

MAIN ASSEMBLY. 40699-A

Item No.	Part No.	Description	Circuit Ref.	Qty. Off.
1	40532-3	Back Plate, Case Assembly		1
2	40529-4	End Plate, Case Assembly		2
3	40530-4	End Frame, Main Casting, Case Assembly		2
4	40700-B	Bottom Panel with Hank Bushes, Case Assembly		1
5	40527-B	Valve Panel Assembly complete. See page 32 for breakdown		1
6	40697-A	Front Panel Assembly complete. See page 33 for breakdown		1
7	20676-7	Tray for Valve Data Manual		1
8	20245-2	Spring Dowel (Holding 2 BA inserts in end frame)		6
9	14802-2	Handle Nut (2 BA inserts in end frame)		6
10	14808-2	Handle Screw (Securing handle to end frame)		6
11	40533-2	Handle (Curved anodised)		2
12	14804-1	Rubber Plug (Mounting for valve/bottom panel)		8
13	14803-2	End Plate Bolt (Special mounting bolt for rubber block)		8
14	W22	Washer $\frac{5}{16}$ " BSF for Item 12		8
15	S1544	Inst. Hd. Screw 4 BA x $\frac{3}{8}$ " N.P. (Main case and end plate fixing screw)		16
16	W72	Cup washer for Item 15		16
17	14807-C	Bracket, Case Assembly		2
18	21205-A	Component Board Assembly. See page 36 for breakdown		1
19	40535-B	Transformer Assembly. See page 36 for breakdown		1
20	P.V.C.21	Mains Lead (8 ft.) (specify length required)		
21	11982-1	Grommet for Mains Lead		1
22	12231-5	Name Plate		1
23	PKS.14	Self Tap Screw No. 2 x $\frac{1}{16}$ " (Secures nameplate)		2
24	14820-1	Ball Catch for hinge rod (Top cover)		2
25	21006-2	Hinge Rod for Valve Base Cover		1
26	12744-4	Bracket securing hinge rod to backplate		3
27	12006-5	Lid grip for Valve Base Cover		1
28	40137-D	Lid Assembly complete. Supplied as assembly		1
29	11237-G	Top Cap Lead		2
30	13763-4	Top Cap Stud (Retains Item 29 when not in use)		2
31	14273-2	Tool Clip (Retains Item 29 when not in use)		3
32	15638-5	Binder for Item 33		2
33	15638-1	Cradle holding cable-form to baseplate		2
34	S202	Ch'se Screw 2 BA x $\frac{5}{8}$ " N.P. Case Assembly Screw		8
35	S203	Ch'se Hd. Screw 2 BA x $\frac{7}{16}$ " N.P.		4
36	S407	Ch'se Hd. Screw 4 BA x $\frac{1}{4}$ " N.P.		6
37	S473	Rd. Hd. Screw 4 BA x $\frac{3}{8}$ " N.P. for holding Item 18		8
38	S608	Ch'se Hd. Screw 6 BA x $\frac{1}{4}$ " N.P. Case Assembly Screws		8
39	S650	Ch'se Hd. Screw 6 BA x $\frac{1}{2}$ " N.P. Holding support for movement mounting		2
40	S643	Rd. Hd. Screw 6 BA x $\frac{3}{8}$ " N.P. (Securing Item 30)		2
41	S808	Rd. Hd. Screw 8 BA x $\frac{1}{8}$ " N.P. for Item 27		2
42	S809	Rd. Hd. Screw 8 BA x $\frac{1}{16}$ " N.P. (Securing Item 30 plug end)		3
43	N.3	Hex. Nut 4 BA N.P.		2

Item No.	Part No.	Description	Circuit Ref.	Qty. Off.
44	N6	Hex. Nut 6 BA N.P. for Item 39		8
45	N12	Hex. Lock-Nut 8 BA N.P. (Securing item 30, plug end)		3
46	N84	Adjusting Nut $\frac{5}{16}$ " BSF C.P. (For item 12)		8
47	W3	Washer 4 BA N.P. for items 37/26		4
48	W6	Washer 6 BA N.P. for item 39		4
49	W8	Washers 8 BA N.P. (Securing item 30, plug end)		3
50	40721-1	Cover (polythene)		1

VALVE PANEL ASSEMBLY. 40527-B

Item No.	Part No.	Description	Circuit Ref.	Qty. Off.
1	40692-B	Valve Panel (Bare)		1
2	40140-1	Valveholder. English 9 Pin		1
3	" 2	" " 7 Pin		1
4	" 3	" American 7 Pin Large		1
5	" 4	" American 4 Pin		1
6	" 5	" English 4/5 Pin		1
7	" 6	" American 5 Pin		1
8	" 7	" English 8 Pin		1
9	" 8	" American 8 Pin		1
10	" 9	" American 6 Pin		1
11	" 10	" 8 Pin Side Contact		1
12	" 11	" B8A		1
13	" 14	" B7G		1
14	15696-1	Valveholder Washer, for Item 11		1
15	10281-1	" B9G		1
16	40140-16	" B8G		1
17	10509-1	" 3 Pin (Diode)		1
18	40140-19	" B9A		1
19	" 20	" American 7 Pin Small		1
20	" 22	" B8D		1
21	15627-1	Plug for Item 20		1
22	21199-A	Holder Assembly for Flying Lead Valveholder		3
23	15617-2	Overlay. Label for Flying Lead Valveholder		1
24	15626-2	Bracket (Securing Item 22)		6
25	15625-1	Mounting Plate for Item 26		1
26	14555-1	Socket. Rubber cup under Flying Lead Valveholder		1
27	20989-2	Front Support Bar		1
28	20990-2	Rear Support Bar		1
29	14805-2	Pillar, stand off, panel to support bars		6
30	11996-A	Tag Board Assembly (Connecting top panel to main assembly)		2
31	20903-B	Top Cap Escutcheon Assembly. See page 40 for breakdown		1
32	20919-2	Top Cap Label (Grid, cathode, etc.)		1
33	14747-1	Ferrox Bead (anti-oscillation, used on wiring)		44
34	40166-3	Cover for roller selector switch		1

Item No.	Part No.	Description	Circuit Ref.	Qty. Off.
35	40157-B	Roller Selector Switch Assembly (Supplied as assembly)		1
36	10511-5	Cap, rear, for Item 17		1
37	N6	Hex. Full Nut 6 BA N.P.		12
38	N62	Hex. Full Nut 4 BA Tin Plt.		8
39	N13	Hex. Nut 10 BA N.P. (Securing item 20)		2
40	S642	Rd. Hd. Screw 6 BA $\frac{3}{8}$ " N.P.		12
41	S661	Rd. Hd. Screw 6 BA $\frac{5}{8}$ " N.P.		10
42	S725	C'sk Hd. Screw 6 BA x $\frac{1}{2}$ " T.P.		2
43	S1001	Rd. Hd. Screw 10 BA x $\frac{1}{2}$ " (Securing item 20)		2
44	S1524	Ch'se Hd. Screw 4 BA x $\frac{9}{16}$ " Tin Plt.		6
45	W4	Washer 5 BA N.P.		2
46	W5	Washer 6 BA N.P.		18
47	W20	Washer 10 BA N.P.		2
48	W66	Washers 4 BA Tin Plt.		4
49	30008-48	Washer used on Item 13		2
50	R88	Eyelet $\frac{3}{16}$ " used on items 14 and 18		4
51	R95	Eyelet $\frac{3}{16}$ " x .125" dia. (Secures Item 13)		2
52	R96	Eyelet $\frac{3}{16}$ " x .148" dia. (Secures Item 2-9/15/16/19)		22
53	R97	Eyelet $\frac{3}{16}$ " x .125" dia. (Secures Item 10)		2

FRONT PANEL ASSEMBLY 40697-A

Item No.	Part No.	Description	Circuit Ref.	Qty. Off.
1	15621-1	Drive Ring mA/V Grid pots		2
2	15620-2	Friction Disc		2
3	15622-2	Friction Collar		2
4	21203-1	Range dial mA/V range switch		1
5	21203-2	Range dial grid range switch		1
6	15623-1	Dial bush. Securing items 4/5 to switch spindle		2
7	20245-52	Spring dowel for item 6		2
8	15619-1	Adjusting plate for pot/dial alignment		4
9	21027-17	Switch mA/V		1
10	21207-16	Switch grid		1
11	14558-9	Potentiometer 10K Ω mA/V		1
12	14558-9	Potentiometer 10K Ω grid		1
13	14822-4	Switch anode volts		1
14	21202-3	Overlay mA/V		1
15	21202-2	Overlay grid		1
16	13483-58	Pillar holding mounting plate item 17/18		8
17	21201-B	Mounting plate mA/V. See page 39 for breakdown		1
18	21201-A	Mounting plate grid. See page 39 for breakdown		1
19	15623-2	Dial bush		2
20	40650-F	Movement assembly complete. See page 37 for breakdown		1
21	21204-2	Dial mA/V Pot		1
22	21204-1	Dial grid Pot		1
23	15630-2	Spring compression, holding items 2/24		2
24	15624-2	Drive collar mA/V—grid pot control		2

Item No.	Part No.	Description	Circuit Ref.	Qty. Off.
25	15220-E	Knob assembly, less skirt mA/V—grid pot control. See page 39 for breakdown		2
26	15220-A	Knob assembly with skirt. See page 38 for breakdown...		11
27	20993-1	Switch heater volts (tens)		1
28	14822-4	Switch screen volts		1
29	20994-1	Switch heater volts (units)		1
30	13657-1	Toggle switch mains		1
31	14558-5	Potentiometer backing off coarse 250Ω	R.V.2.	1
32	14558-4	Potentiometer backing off fine 25Ω	R.V.1.	1
33	14812-1	Dial light holder for item 34		1
34	50010-14	Bulb 6.5V .3 amp.	L.P.1.	1
35	20994-1	Switch set c/s		1
36	13657-1	Toggle switch A1, A2, Normal		1
37	20996-1	Switch electrode selector		1
38	20992-1	Switch leakage		1
39	40696-1	Front panel (bare)		1
40	20997-1	Switch meter		1
41	20991-1	Switch Circuit Selector		1
42	14750-2	Pillars, spacing, fixing item 43 to front panel		4
43	14810-4	Movement board		1
44	12075-4	Bracket for item 43		2
45	20006-2	Gasket for movement assembly		1
46	15698-2	Window mask (mA/V—grid windows)		2
47	15697-2	Mask pillar for item 46		2
48	15638-2	Cradle holding 8 μF condenser item 68		1
49	15638-7	Binder for item 48		1
50	11310-A	Tag board assembly for switch connections items 9 and 10. See page 39 for breakdown		2
51	14941-8	Spacer between item 50 and item 39		4
52	13659-7	Cable clip on item 50		1
53	10266-1	Tag 2BA		2
54	N3	Hex. nut 4BA		1
55	N6	Hex. Nut 6BA		6
56	R61	Rivet .090"/.094" dia. x $\frac{11}{16}$ ". Fixing item 6/16 to items 4/5/21/22		12
57	S407	Cheese head screw 4BA x $\frac{1}{4}$ " nickel plated		9
58	S461	Round head screw 4BA x $\frac{3}{8}$ " nickel plated steel		15
59	S477	Cheese head screw 4BA x $\frac{1}{4}$ "		1
60	S602	Cheese head screw 6BA x $\frac{3}{16}$ " nickel plated		2
61	S603	Cheese head screw 6BA x $\frac{5}{8}$ " nickel plated		4
62	S606	Cheese head screw 6BA x $\frac{3}{8}$ "		2
63	S813	Cheese head screw 8 BA x $\frac{1}{16}$ " nickel plated		4
64	AS23	Socket grub screw 4BA x $\frac{3}{16}$ " securing item 1		8
65	W3	Washer 4BA nickel plated		25
66	W5	Washer 6BA		8
67	W8	Washer 8BA nickel plated		4
68	15581-12	Silicon diode Type SD91	MR7. MR8.	2

Item No.	Part No.	Description	Circuit Ref.	Qty. Off.
69	12049-404	Condenser 8 μ F	C.1.	1
70	12049-443	Condenser .01 μ F. 250V	C.2.	1
71	12049-731	Condenser 8 μ F 12V reversible	C.3.	1
72	14709-B	Resistor 200 Ω \pm .5%	R36.	1
73	12049-421	" 300 Ω " 1%	R5.	1
74	12049-250	" 470 Ω " 10%	R45.	1
75	12049-401	Resistor 500 Ω \pm 2 $\frac{1}{2}$ % Vit	R37.	1
76	12049-389	" 600 Ω " 2%	R18.	1
77	" 422	" 760 Ω " 2%	R2.	1
78	" 422	" 760 Ω " 2%	R39.	1
79	" 423	" 1860 Ω " 1%	R4.	1
80	" 424	" 2K Ω " 1%	R3.	1
81	" 425	" 2.5K Ω " 1%	R7.	1
82	" 425	" 2.5K Ω " 1%	R8.	1
83	" 425	" 2.5K Ω " 1%	R9.	1
84	" 425	" 2.5K Ω " 1%	R10.	1
85	" 425	" 2.5K Ω " 1%	R11.	1
86	" 425	" 2.5K Ω " 1%	R12.	1
87	" 425	" 2.5K Ω " 1%	R13.	1
88	" 425	" 2.5K Ω " 1%	R14.	1
89	" 426	" 2.9K Ω " 1%	R31.	1
90	" 390	" 3K Ω " 2%	R17.	1
91	" 427	" 3.54K Ω " 1%	R15.	1
92	" 397	" 4.35K Ω " 2%	R27.	1
93	" 428	" 6.8K Ω " 1%	R32.	1
94	" 385	" 10K Ω " 2%	R34.	1
95	" 386	" 10K Ω " 1%	R35.	1
96	" 391	" 15K Ω " 2%	R16.	1
97	" 701	" 16.8K Ω " 1%	R41.	1
98	" 429	" 21.8K Ω " 1%	R30.	1
99	" 95	" 24.K Ω " 10% Vit.	R38.	1
100	" 420	" 25.6 Ω " 1%	R6.	1
101	" 703	" 25.9K Ω " 1%	R43.	1
102	" 396	" 31.5K Ω " 2%	R26.	1
103	" 702	" 37.9K Ω " 1%	R42.	1
104	" 700	" 51.8K Ω " 1%	R20.	1
105	" 241	" 56K Ω " 5% Vit.	R33.	1
106	" 430	" 59.6K Ω " 1%	R29.	1
107	" 395	" 100K Ω " 2%	R25.	1
108	" 394	" 202K Ω " 2%	R24.	1
109	" 431	" 249K Ω " 1%	R28.	1
110	" 393	" 406K Ω " 2%	R23.	1
111	" 392	" 814K Ω " 2%	R22.	1
112	" 432	" 1.22M Ω " 2%	R21.	1
113	" 433	" 2.96M Ω " 1%	R19.	1
114	" 434	" 3.9 Ω " 20%	R47.	1
115	" 632	" 10K Ω " 2%	R46.	1

Item No.	Part No.	Description	Circuit Ref.	Qty. Off.
116	30008-77	Washer for incremental drive $\frac{7}{8}$ " \times $\frac{1}{16}$ " 0.535" hole	...	1
117	13659-5	Cable Clip $\frac{1}{4}$ "	...	2

COMPONENT BOARD ASSEMBLY 21205-A

Item No.	Part No.	Description	Circuit Ref.	Qty. Off.
1	21200-3	Component board bare	...	1
2	12049-244	Resistor 100K Ω \pm 10%	R1.	1
3	,, 244	Resistor 100K Ω \pm 10%	R40.	1
4	10770-32	Potentiometer 5K Ω	RV4.	1
5	10770-32	Potentiometer 5K Ω	RV6.	1
6	12049-704	Rectifier 1/6th Amp.	MR1.	1
7	15581-11	Silicon diode Type SD94	MR3, MR9.	2
8	15581-11	Silicon diode Type SD94	MR4, MR10.	2
9	15581-11	Silicon diode Type SD94	MR5, MR6.	2
10	15581-11	Silicon diode Type SD94	MR11, MR12.	2
11	13935-4	Washer for item 5	...	2
12	13935-2	Spindle lock for item 5	...	2
13	13062-2	Link	...	1
14	10944-2	Pillar Tags	...	14
15	15628-2	Bracket, mounting board assembly	...	2
16	13834-A	Knob, slotted terminal pattern	...	2
17	14242-4	Socket, threaded for item 16	...	2
18	14247-2	Spring washer for item 17	...	2
19	14243-2	Hex. nut for item 17...	...	2
20	14657-2	Link between item 16	...	1
21	N3	Hex. nut 4BA nickel plated...	...	4
22	N6	Hex. nut 6BA nickel plated...	...	1
23	N7	Hex. lock nut 6BA	...	1
24	PKS4	Self tapping screw	...	2
25	S420	Cheese head screw 4BA $\frac{7}{16}$ " nickel plated	...	4
26	S644	Round head screw 6BA $\frac{1}{2}$ " nickel plated	...	1
27	W1	Washer 2BA nickel plated	...	1
28	W3	Washer 4BA nickel plated	...	4
29	W5	Washer 6BA nickel plated	...	1
30	10040-1	Tag	...	2

TRANSFORMER ASSEMBLY 40535-B

Item No.	Part No.	Description	Circuit Ref.	Qty. Off.
1	21002-D	H.T. and Grid Transformer. Supplied only as complete assembly	...	1

Item No.	Part No.	Description	Circuit Ref.	Qty. Off.
2	21029-D	Grid Transformer assembly. Supplied only as complete assembly		1
3	21005-B	L.T. Transformer assembly. Supplied only as complete assembly		1
4	40466-B	Relay assembly. See page 39 for breakdown		1
5	14809-2	Pillar, support for item 4		4
6	11673-3	Pillar, support for items 7 and 8		2
7	21000-2	Rear transformer bar		1
8	20999-2	Front Transformer bar		1
9	15029-D	Fuse board assembly. See page 40 for breakdown		1
10	13659-1	Insuloid Clip, securing lead cable form		2
11	20998-C	Bracket securing items 7/8 to base plate		2
12	N1	Hex. Nut 2BA nickel plated		4
13	N62	Hex. Nut 4BA tin plated		24
14	S203	Cheese head screw 2BA x $\frac{7}{16}$ " nickel plated		4
15	S420	Cheese head screw 4BA x $\frac{7}{16}$ " nickel plated		10
16	W66	Washer 4BA tin plated		4

MOVEMENT AND CASE ASSEMBLY 40650-F

Item No.	Part No.	Description	Circuit Ref.	Qty. Off.
1	40537-2	Front case		1
2	40538-B	Rear case		1
3	Misc. 139	Rubber approx. 16" sealing items 1 and 2		1
4	12730-2	Front case glass		1
5	14823-2	Hex. stud. Securing items 1 and 2		4
6	N22	Round nut 6BA for item 5		4
7	10054-1	Movement zero adjuster		1
8	10077-4	Main fixing stud 2BA		2
9	10064-1	Tag for item 8		2
10	40651-C	Basic movement assembly. See below for breakdown		1
11	N2	Hex. lock nut 2BA		2
12	N4	Hex. lock nut 4BA		3
13	S751	Inst. Head screw 6BA x $\frac{1}{4}$ " Brass nickel plated		1
14	30006-W	Wound bobbin swamp 900 Ω approx.		1
15	15438-2	Magnetic shunt		1
16	12927-1	Movement end stops		2
17	30008-10	Washer for swamp bobbin		1
18	15440-1	Hex. pillar support for item 10		2
19	S401	Cheese head screw 4BA x $\frac{1}{8}$ "		1
20	S804	Cheese head screw 8BA x $\frac{1}{8}$ "		2

BASIC MOVEMENT ASSEMBLY 40651-C

Item No.	Part No.	Description	Circuit Ref.	Qty. Off.
1	14824-4	Scale plate		1
2	15439-1	Mounting plate for item 1		1

Item No.	Part No.	Description	Circuit Ref.	Qty. Off.
3	15301-1	Magnet		1
4	21122-2	Support plate for item 3		1
5	15303-2	Concentrator		1
6	15296-2	Pole piece		1
7	21121-1	Concentrator support		1
8	21124-D	Moving coil assembly. See below for breakdown		1
9	21123-2	Yoke		1
10	15436-1	Zero adjuster		1
11	15437-1	Movement support pillar		2
12	10184-B	Sprung jewel assembly		2
13	10190-1	Insulator, bush for rear hairspring tag		1
14	10188-2	Lock nut for item 13		1
15	10191-3	Rear hairspring tag		1
16	10069-1	Spring washer for item 10		1
17	10197-2	Lock nut for item 16		1
18	10189-1	Washer for item 15		2
19	10358-2	Tag for movement connection		1
20	N4	Hex. lock nut 4BA		2
21	N11	Hex. nut 8BA		2
22	S802	Cheese head screw 8BA x $\frac{1}{8}$ " nickel plated		1
23	S804	Cheese head screw 8BA x $\frac{1}{8}$ " nickel plated		1
24	S824	Cheese head screw 8BA x $\frac{3}{8}$ " nickel plated		1
25	S877	Inst. head screw 8BA x $\frac{3}{16}$ " nickel plated		2
26	S882	Cheese head screw 8BA x $\frac{11}{16}$ " nickel plated		2
27	S886	Cheese head screw 8BA x $\frac{11}{16}$ " nickel plated		1
28	S887	Cheese head screw 8BA x $\frac{3}{32}$ "		1
29	W8	Washer 8BA nickel plated		3

MOVING COIL ASSEMBLY 21124-D

Item No.	Part No.	Description	Circuit Ref.	Qty. Off.
1	15304-3	Moving coil bare		1
2	10161-1	Pivot plate		1
3	10159-1	Pivot holder		2
4	10084-1	Tag. for hairsprings		2
5	10162-1	Pad for items 2 and 8		4
6	10158-4	Pivots .020"		2
7	10075-16	Hairspring		2
8	15300-1	Pointer plate		1
9	15433-1	Pointer		1

KNOB ASSEMBLY 15220-A

Item No.	Part No.	Description	Circuit Ref.	Qty. Off.
1	14267-1	Knob		1
2	14268-4	Knob skirt, silver with marker line		1
3	14266-6	Knob carrier		1

Item No.	Part No.	Description	Circuit Ref.	Qty. Off.
4	14269-4	Retaining nut...	...	1
5	15066-2	Knob washer, between items 2 and 4	...	1
6	20245-52	Spring dowel $\frac{9}{16}$ " x $\frac{1}{8}$ " dia.	...	1
7	S745	Screw, knob securing	...	1
8	W39	Spring washer. 6BA phos. bronze, double coil	...	1

KNOB ASSEMBLY 15220-E

1	14267-1	Knob	...	1
2	14670-2	Knob carrier	...	1
3	20245-52	Spring dowel $\frac{9}{16}$ " x $\frac{1}{8}$ " dia.	...	1
4	S745	Screw, knob securing	...	1
5	W39	Spring washer. 6BA phos. bronze, double coil	...	1

MOUNTING PLATE, "GRID VOLTS" 21201-A

1	15618-1	Control mounting plate	...	1
2	14606-3	Hex. hank bushes	...	2

MOUNTING PLATE "MA.V" 21201-B

1	15618-1	Control mounting plate	...	1
2	14606-3	Hex. hank bushes	...	2

TAG BOARD ASSEMBLY 11310-A

1	11297-1	Tag board	...	1
2	10040-3	Tags	...	8

RELAY ASSEMBLY 40466-B

1	40466-24	Relay board tagged	...	1
2	14655-2	Nyloc anchor plate	...	1
3	14548-4	Contact	...	1
4	14650-A	Contact screw	...	1
5	14643-2	Armature bare	...	1
6	10466-2	Armature contact	...	1
7	11832-5	Split pin for items 8 and 9	...	2
8	14648-2	Spring, compression, armature holding	...	1
9	14644-2	Spring retainer for item 8	...	2
10	14646-2	Armature spring pull-on/off	...	1
11	14642-2	Pole piece	...	1
12	20885-G	Wound bobbin	...	1
13	20885-B	Wound bobbin, pair, nearest item 1	...	2
14	14645-2	Armature retainer	...	1
15	13658-2	Anchor plate	...	1
16	10358-1	Tag for item 2	...	1
17	14646-2	Contact spring (Leaf)	...	1

Item No.	Part No.	Description	Circuit Ref.	Qty. Off.
18	N58	Hex. stiff nut 4BA		1
19	N81	Hex. nut 8BA tin plated		4
20	S723	Cheese head screw 6BA x $\frac{1}{4}$ " tin plated		4
21	S866	Cheese head screw 8BA x $\frac{5}{16}$ " tin plated		4
22	S1527	Cheese head screw securing item 15 4BA x $\frac{5}{8}$ " tin plated		1
23	W54	Washer 6BA (Spring)		2
24	W69	Washer 8BA tin plated		4
25	15637-1	Copper pole piece		1
26	15581-5	Silicon diode. Type SD94	MR2.	1
27	12049-473	Resistor 2.2K Ω \pm 5% vit.	R44.	1

FUSE BOARD ASSEMBLY 15029-D

Item No.	Part No.	Description	Circuit Ref.	Qty. Off.
1	15026-6	Fuse board		1
2	12239-7	Fuse clip		8
3	R102	Eyelets for item 2		8
4	12239-3	Fuse 3A	FS1.	1
5	10040-3	Tags		2
6	10064-1	Tag 4BA		1
7	15699-2	Bracket		2
8	N3	Hex. nut 4BA nickel plated...		4
9	S409	Cheese head screw 4BA x $\frac{5}{8}$ " nickel plated		2
10	W3	Washer 4BA nickel plated		2

TOP CAP ESCUTCHEON ASSEMBLY 20903-B

1	40467-1	Top cap escutcheon		1
2	14661-1	Sockets plain. "CLIX" Part No.: S309		9
3	14242-4	Sockets threaded		4
4	14657-2	Link		2
5	13834-A	Knob link securing		4
6	14243-2	Hex. nut locking item 5		4
7	14247-3	Spring washer for item 5 and 6		4
8	14656-1	Spring		2
9	N7	Hex. lock nut 6BA nickel plated		4
10	S661	Round head screw 6BA x $\frac{3}{16}$ " nickel plated		2

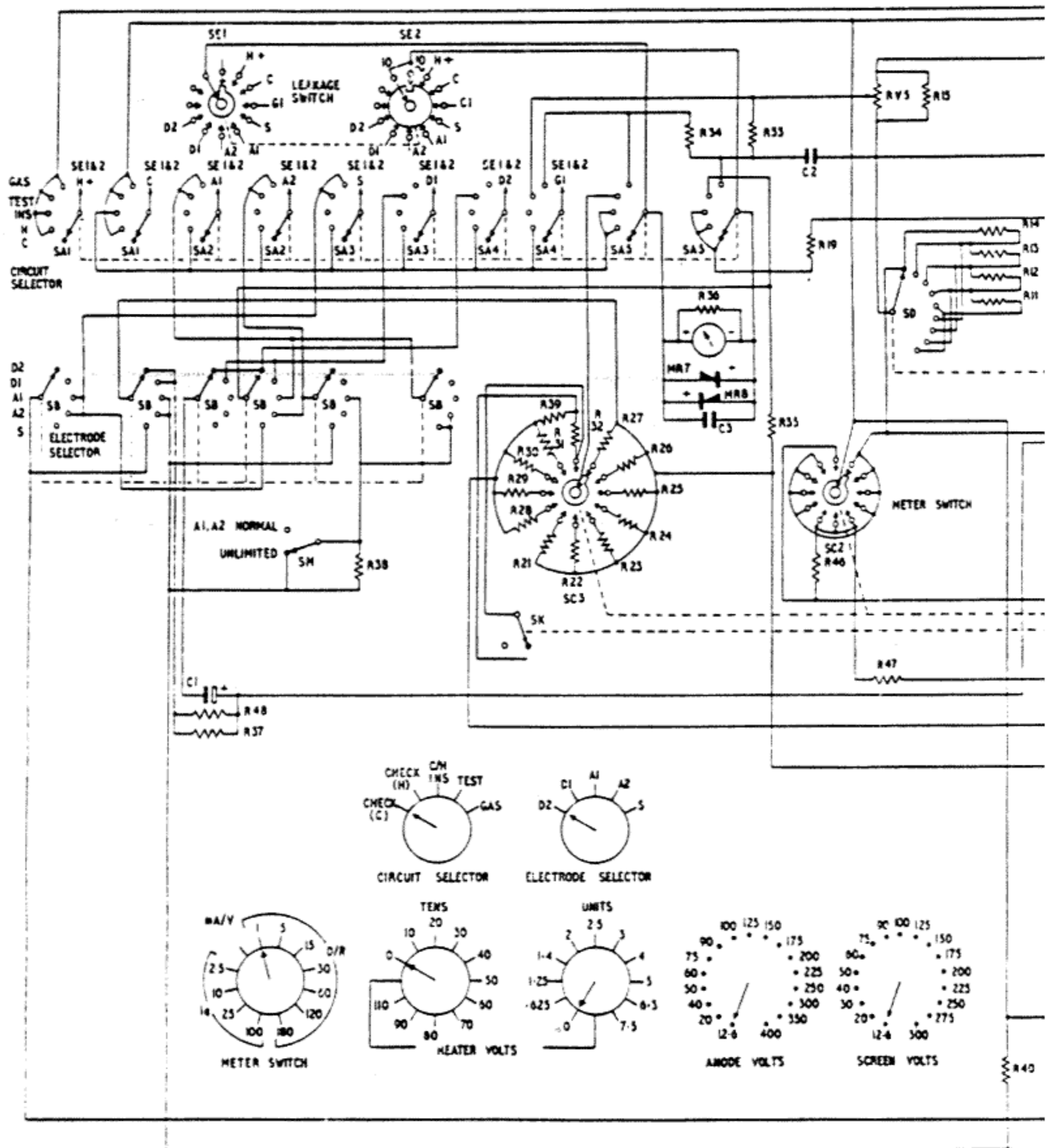

CIRCUIT DIAGRAM OF 'AVO' VALVE CHARACTERISTIC METER. Mk. IV.

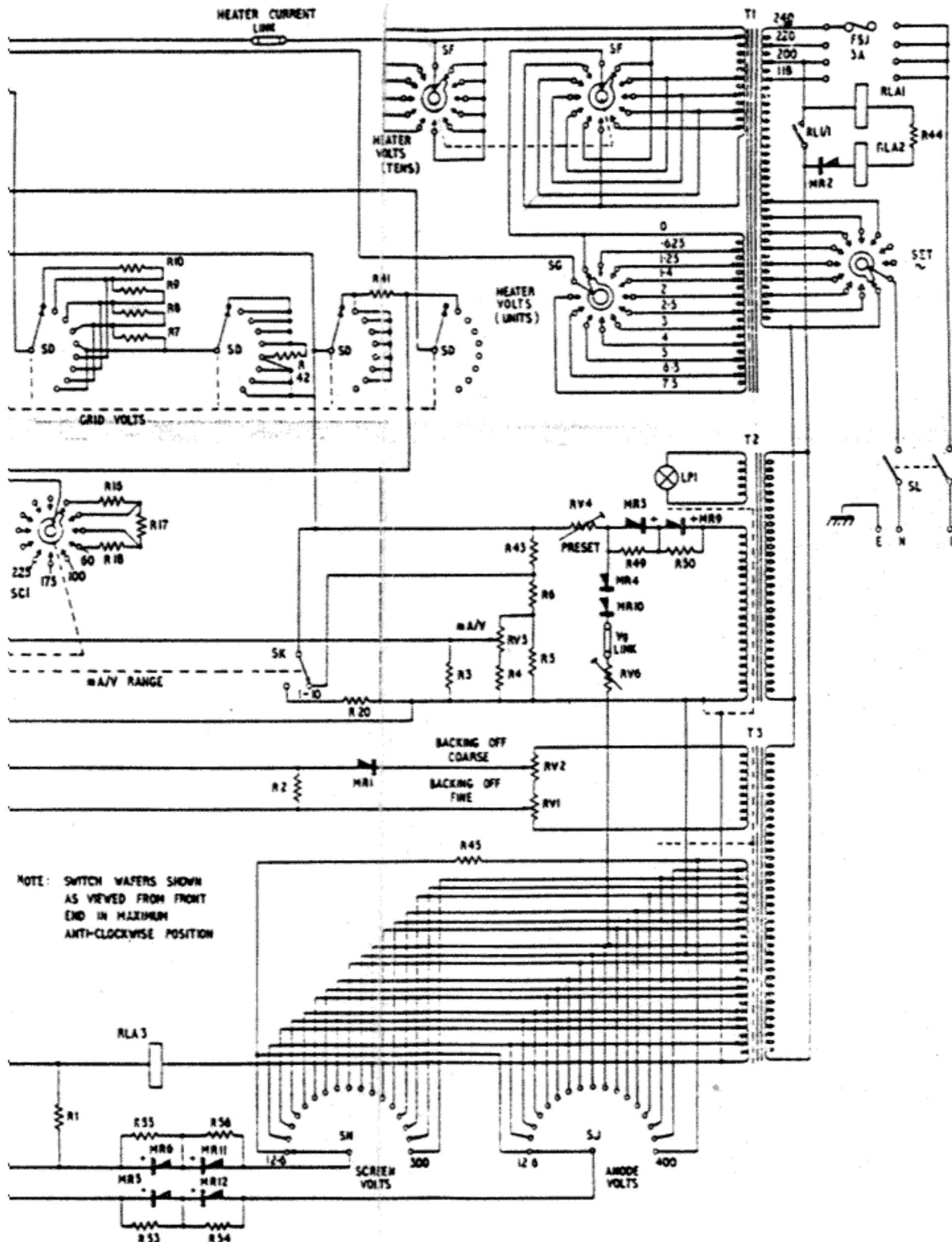

NOTE: SWITCH WAFERS SHOWN AS VIEWED FROM FRONT END IN MAXIMUM ANTI-CLOCKWISE POSITION

CIR. REF.	TOL	VALUE
R1	$\pm 10\%$	100 K Ω
R2	$\pm 2\%$	760 Ω
R3	$\pm 1\%$	2K Ω
R4	$\pm 1\%$	1860 Ω
R5	$\pm 1\%$	300 Ω
R6	$\pm 1\%$	25.6K Ω
R7	$\pm 1\%$	2.5K Ω
R8	$\pm 1\%$	2.5 K Ω
R9	$\pm 1\%$	2.5 K Ω
R10	$\pm 1\%$	2.5 K Ω
R11	$\pm 1\%$	2.5K Ω
R12	$\pm 1\%$	2.5 K Ω
R13	$\pm 1\%$	2.5 K Ω
R14	$\pm 1\%$	2.5 K Ω
R15	$\pm 1\%$	3.5 K Ω
R16	$\pm 2\%$	15 K Ω
R17	$\pm 2\%$	3 K Ω
R18	$\pm 2\%$	600 Ω
R19	$\pm 1\%$	2.96 M Ω <small>Matching Pair</small>
R20	$\pm 1\%$	51.8 K Ω
R21	$\pm 2\%$	1.22 M Ω
R22	$\pm 2\%$	814 K Ω
R23	$\pm 2\%$	406 K Ω
R24	$\pm 2\%$	202 K Ω
R25	$\pm 2\%$	100 K Ω
R26	$\pm 2\%$	31.5 K Ω
R27	$\pm 2\%$	4.35 K Ω
R28	$\pm 1\%$	249 K Ω
R29	$\pm 1\%$	59.6 K Ω
R30	$\pm 1\%$	21.8 K Ω
R31	$\pm 1\%$	2.9 K Ω
R32	$\pm 1\%$	6.8 K Ω
R33	$\pm 10\%$	56 K Ω
R34	$\pm 2\%$	10 K Ω
R35	$\pm 1\%$	10 K Ω
R36	$\pm 5\%$ $\pm 0\%$	190 Ω <small>overwound</small> 200 Ω $\pm 5\%$
R37	$\pm 2.5\%$	1 K Ω
R38	$\pm 10\%$	24 K Ω
R39	$\pm 1\%$	1 K Ω
R40	$\pm 10\%$	100 K Ω
R41	$\pm 1\%$	16.8 K Ω
R42	$\pm 1\%$	37.9 K Ω
R43	$\pm 1\%$	25.9 K Ω
R44	$\pm 5\%$	2.2 K Ω
R45	$\pm 10\%$	470 K Ω
R46	$\pm 2\%$	10 K Ω
R47	$\pm 20\%$	2 Ω
R48	$\pm 2.5\%$	1 K Ω
R49	$\pm 20\%$	2.2 M Ω
R50	$\pm 20\%$	2.2 M Ω
R51	—	—
R52	—	—
R53	$\pm 20\%$	2.2 M Ω
R54	$\pm 20\%$	2.2 M Ω
R55	$\pm 20\%$	2.2 M Ω
R56	$\pm 20\%$	2.2 M Ω