

Accuphase

STEREO POWER AMPLIFIER

P-600



7-parallel push-pull power stages guarantee stereo = 300 W/ch (8 ohms)

By using the low impedance setting, even an extreme low impedance

The advent of new audio program sources such as the Compact Disc (CD) and Digital Recordings (PCM) has ushered in an era where the true capabilities of power amplifiers are being more closely examined and increasingly appreciated. This is because an amplifier's capability to reproduce musical range, details and depth cannot be judged merely from its rated specifications. Higher-grade power amplifiers must be endowed not only with superior basic characteristics, but with the capability and power to drive speakers correctly with ample energy so that they can respond accurately to instantly changing, wide-ranging signal variations.

This necessitates a power supply with ample reserve margin to provide the full energy required by a powerful output circuit that is driven by a large current capacity driver stage. In other words, the impedance of the loop circuitry formed by the power supply and the power output circuit which supplies energy to the speakers must be very low, in fact, as close to "0" as possible. Moreover, low impedance should be one of the most desired basic characteristics of this loop circuit before Negative Feedback (NFB) or Constant Voltage Regulation or both are applied to lower the impedance still further.

Other fundamental requisites of a good power amplifier must include wide dynamic range, low distortion against both static and dynamic input signals, and sturdy construction that assures highest stability and complete absence of electrical and mechanical resonances.

The Accuphase P-600 Stereo Power Amplifier is a product that was developed to meet the needs of the new audio era with a design approach that incorporated all the above basic fundamentals. It produces a pure and powerful output of 300 W/ch at 8 ohms with its "Push-Pull Circuitry in every stage" that culminates in a "Seven-Parallel push-pull" output stage comprising a total of 14 bipolar transistors that is driven by a driver stage centered on powerful MOS FETs (Metal Oxide Semiconductor Field Effect Transistors). It boasts an extra heavy-duty power supply which, together with its powerful output stage, is completely capable of driving a low 2-ohm impedance load with 700 watts of power to each channel. Furthermore, it is also equipped with a built-in "Low Load Impedance Drive" capability that permits it to work into a one-ohm load with a power output of 450 W/ch. It is the first power amplifier in the world that can directly drive a one-ohm impedance load. This means that it has an ample reserve margin of power when used to drive normal speaker impedances. It thus assures ideal constant voltage regulation regardless of actual speaker impedance fluctuations under actual operating conditions.

The P-600 also has a built-in Bridge Circuit that permits it to be used as a pure monophonic power amplifier that can deliver a high 1,000 watts of power into 8 ohms.

The P-600 is also equipped with an input for a 600-ohm balanced cable network with which a matched connection can be made to the Accuphase C-280 preamplifier, or to any commercial amplifier with an output connector for a 600-ohm balanced type connecting cable. The P-600 also enables accurate, direct reading of

power output peak values with a digital display system initially developed for the Accuphase M-100 Monophonic Power Amplifier.

We invite you to enjoy the stirring excitement of good music reproduction to your heart's content with the P-600 which has power to spare and is fully capable of providing this thrilling experience.

1 7-PARALLEL PUSH-PULL OUTPUT STAGE GUARANTEES 700 W/ch AT 2 OHMS, 300 W/ch AT 8 OHMS

The P-600 has a rated power output of 300 W/ch at 8 ohms, 500 W/ch at 4 ohms and 700 W/ch at 2 ohms. (20–200,000 Hz; distortion ratio less than 0.02 percent)

To guarantee such high power outputs, it has a total of 24 bipolar power transistors, each of which has a superior wideband characteristic and maximum power dissipation (P_c) of 200 watts, that form a 7-parallel push-pull output circuitry which has a total electrical capacity of 2.8 kW. Figure 1 shows the circuit diagram in which Q19–Q32 constitute the 14 output transistors. They are attached to giant heat sinks that adequately dissipate the heat generated at the high power levels.

2 1-OHM SPEAKER NETWORK LOAD CAN BE DRIVEN AT 450 W/ch

Although the P-600 can be used to drive a 2-ohm load under normal operation, it is further equipped with a "Low Load Impedance Operation" Switch which permits it to drive even lower impedance loads for special commercial applications. This enables the P-600 to be connected to a one-ohm impedance speaker network and deliver 450 W/ch while safely protecting the output transistors and supplying the large current flows required. Speakers with impedances ranging from 1–16 ohms can thus be connected to the P-600 which makes this

Stereo Power Amplifier most useful when a number of speakers are connected in parallel.

3 DARLINGTON CASCODE PUSH-PULL PRE-DRIVER AND MOS FET DRIVER STAGES IMPROVE LINEARITY AND ELIMINATE SWITCHING DISTORTION

Unlike listening in large auditoriums, the distance between the listener and speakers is very small in the home and the most subtle sounds are audible. Therefore, sound quality at low listening levels below several watts is a very important factor. We adopted a sure way to obtain highest quality reproduction at such levels by using MOS FETs for voltage amplification in the driver stage. This application is an Accuphase original with a proven record of ensuring the required low output impedance and large current capacity to drive the final output stage properly. Use of MOS FETs also greatly improves high frequency characteristics.

Furthermore, the low thermal characteristics of MOS FETs helps to stabilize bipolar transistor operation, which in turn, stabilizes bias current flow of the power output stage. This has enabled us to reduce the value of emitter resistance. Moreover, the 7-parallel output transistor connection has made it possible to reduce the value of the seven emitter resistors to one-seventh, resulting in the practical elimination of switching distortion which is created when the bias current of the output transistor is cut off.

Q11–Q16 constitute the cascode push-pull Pre-driver Stage which assures both excellent linearity and large amplitude handling capability with complete absence of Miller effects. This stage drives the MOS FET Driver Stage. It has a high input impedance, thanks to the Darlington circuit formed by Q11 Q13 and Q12 Q14. This assures high quality amplification since it does not affect the operation of the differential amplifier input circuit.

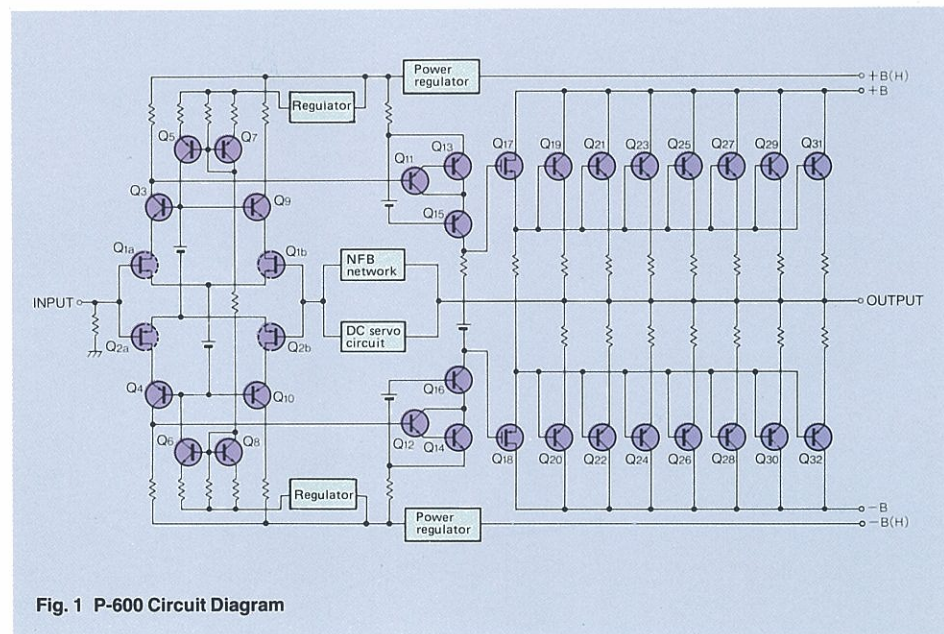
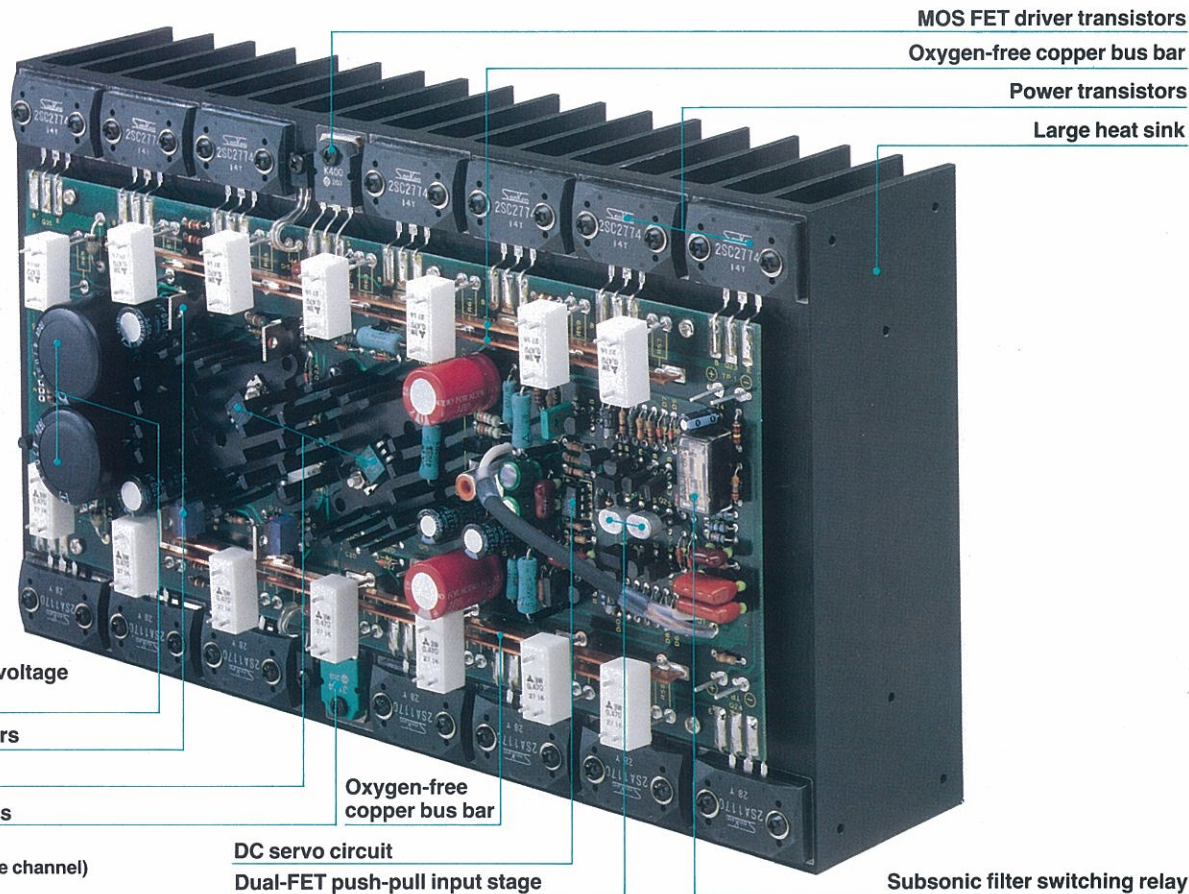

Fig. 1 P-600 Circuit Diagram

), monophonic = 1,000 W (8 ohms).
 speaker (1 ohm) can be fully driven.



Filter capacitors for high-voltage power supply

Power regulator transistors

Pre-drive transistors

MOS FET driver transistors

Oxygen-free copper bus bar

DC servo circuit

Dual-FET push-pull input stage

Subsonic filter switching relay

● Power Amp. Unit Ass'y (one channel)

4 CASCODE BOOTSTRAP PUSH-PULL DIFFERENTIAL AMPLIFIER INPUT SECTION

Q1-Q2 are Field Effect Transistors (FETs) which form the differential amplifier input section. Q3-Q4 form the bootstrap circuit and Q1a-Q3, Q2a-Q4 the cascode amplifier. Together they constitute the Cascode Bootstrap Input Section. It features high gain and improved high frequency characteristics. It also prevents distortion when input impedance is increased, as when the input level control is varied. The excellent distortionless characteristics of the P-600 are supported by actual measured data as shown, which reveal the complete absence of harmful IM (intermodulation distortion) and TIM (transient intermodulation distortion).

5 DC SERVO CONTROLLED DIRECT COUPLED INPUT STAGE

Use of dual FETs in the input circuit prevents DC drift within the amplifier and permits direct coupling and the elimination of input coupling capacitors. However, DC leakage from a preamplifier can cause DC current to appear at the output and possibly damage the speakers if it is not earlier eliminated. The P-600 has a DC Servo Control circuit which effectively prevents this danger by blocking passage of all DC leakage or drift. Figure 1 shows the Servo Control circuit which is connected to the inverted input of the differential amplifier.

6 BRIDGE CONNECTION PERMITS PURE MONOPHONIC OPERATION WITH 1,000 WATTS AT 8 OHMS and 1,400 WATTS AT 4 OHMS

If each stereo power amplifier of the P-600 is taken as a single device and used together respectively with a bridge connection as a push-pull monophonic driver, a very large monophonic power output can be obtained. Figure 2 shows the principle in which an identical waveform is fed to the respective left and right channels in counterphase. Connecting the speakers then to the output of both amplifiers will double the signal input voltage to the speakers which theoretically quadruples the power of the single amplifier.

Another advantage of counterphase operation is improved characteristics due to the elimination of harmonic distortion as even-number harmonics are cancelled out. Also the

plus and minus phases of energy from the power supply are fed alternately to the respective amplifiers, and never in the same direction to both. This decreases power supply voltage fluctuations and ensures sufficient energy with good linearity characteristics to drive the speaker.

Bridging the two channels provides a monophonic power output of 1,000 Watts at 8 ohms and 1,400 Watts at 4 ohms. The P-600 can deliver 900 watts output at 2 ohms when used in the "Low Load Impedance-Operation" mode.

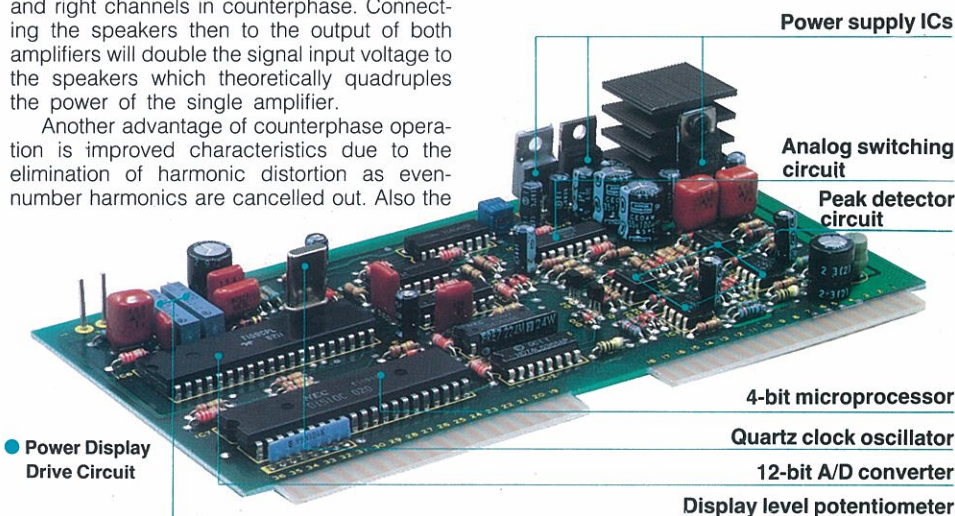

Power supply ICs

Analog switching circuit

Peak detector circuit

4-bit microprocessor

Quartz clock oscillator

12-bit A/D converter

Display level potentiometer

● Power Display Drive Circuit

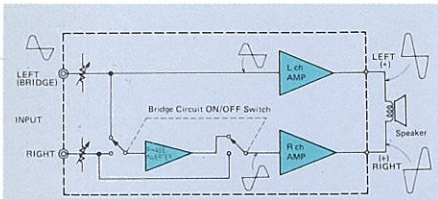

Fig. 2 Principle of the Bridging Connection

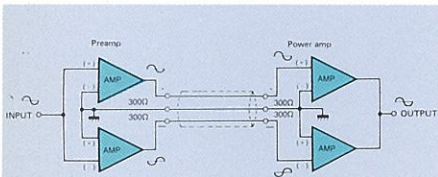
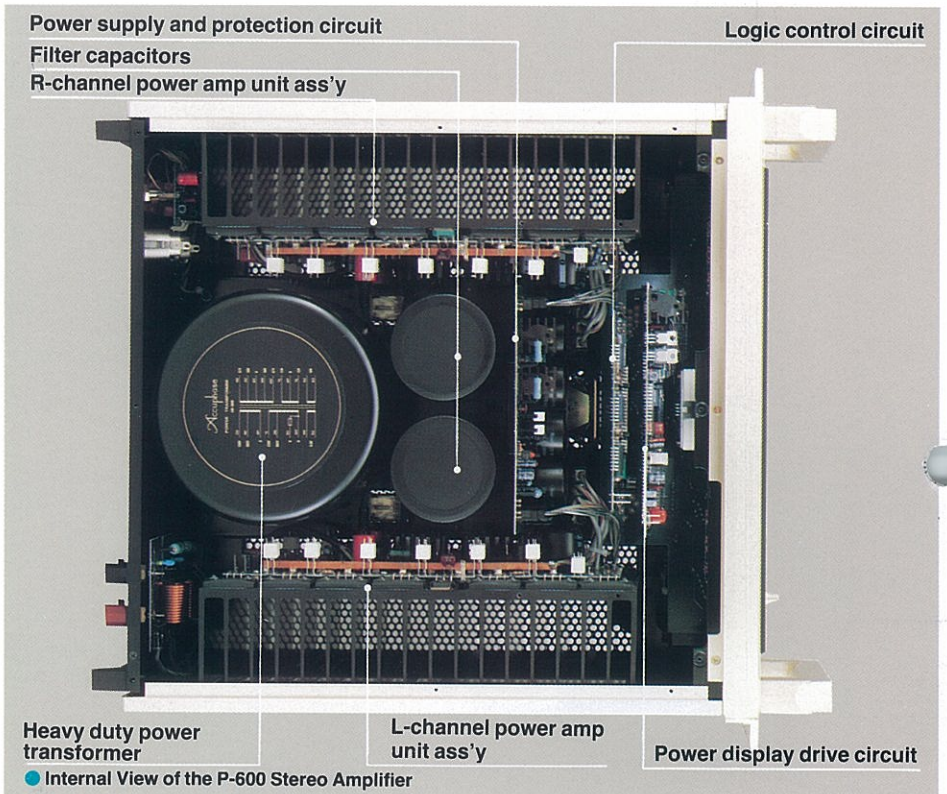
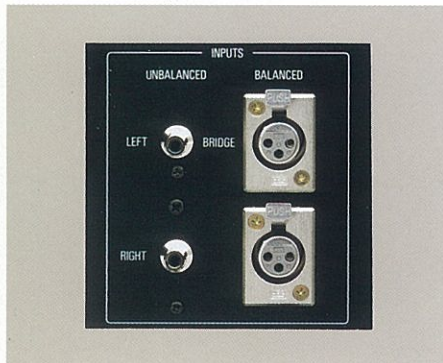

Fig. 3 Principle of the Balanced Type Network

7 INPUT CONNECTOR FOR 600-OHM BALANCED TYPE CABLE NETWORK ENABLES LENGTHY CONNECTIONS WITH NO NOISE PICKUP

The use of a 600-ohm balance type cable network has long been a standard practice of broadcasting stations and commercial applications where lengthy cable connections are necessitated, but noise pickup must be prevented. Besides the conventional unbalanced input connector (phono jack) of 20 k ohms, this power amplifier is provided with a genuine 600-ohm Balanced Input Connector (3P XLR cannon type).

The principle is shown in Figure 3 in which equal positive and negative signal voltages in relation to ground potential are transmitted by the balanced cable network. Even if unwanted noise disturbances happen to be picked up by the cable, the positive and negative noise signals will appear in the same phase at the input of the differential amplifier where they are cancelled out. This prevents lengthy interconnecting cables from deteriorating sound quality. Since the Accuphase C-280 Preamp also has an output connector for 600-ohm balanced type connecting cables, the two components can be used very effectively for lengthy interconnections. Phase reversal to cancel out noise pickup is, of course, accomplished in this power amplifier, with a low distortion, wideband differential amplifier circuit instead of a simple transformer.



Internal View of the P-600 Stereo Amplifier

8 DIRECT READOUT SYSTEM OF PEAK POWER BY DIGITAL DISPLAY

The P-600 is equipped with a peak power direct reading digital display system. It was initially developed for the Accuphase M-100 (500 W Monophonic Power Amplifier) for the first time in the world and was quickly recognized as a fitting power meter for the new audio era.

The Digital Power Meter System includes a 12-bit A/D Converter and a 4-bit micro-processor. The analog signal is converted into a digital signal by the former and is accurately displayed numerically in 3 digits. A Power Range Switch is varied in 4 steps, i.e., 1x, 0.1x, 0.01x and 0.001x and permits direct reading of power output from 0.001 to 999 W. "Hold Time" is selectable in two ranges, i.e., 3 seconds and 30 minutes. The latter will show the peak value reached on one side of a record and reveals the maximum cutting level for that record.

As the Digital Display indicates the power value as converted from the output voltage, the actual power delivered to the speakers will vary greatly depending on the impedance of the speaker. Therefore, an Impedance Selector Switch is provided exclusively for use with the Power Meter so that accurate power output readings can be obtained by adjusting it to the impedance of the speaker. The switch can be set to 2, 8 or 16 ohms.

9 1 dB STEPPING PRECISION ATTENUATOR

A communication equipment type 25-step

genuine attenuator which utilizes high-precision resistors is provided. It offers 1 dB step attenuation from 0 to -20 dB, and thereafter at -23 dB, -26 dB, -30 dB and within ± 0.1 dB.

10 10 Hz SUBSONIC FILTER WITH -12 dB/oct SLOPE

Subsonic vibrations can cause undesirable speaker response and harm sound quality. This amplifier has a Subsonic Filter to prevent this.

It cuts off all frequencies below 10 Hz (-12 dB/oct) which effectively prevents disturbances from subsonic vibrations. Switching is controlled from the front panel but is made with a relay attached to the circuit board. In other words, shortest possible signal path leads are used to preserve sound quality.

11 PROVISION FOR VENTILATION FAN INSTALLATION

It is not necessary to use forced ventilation for ordinary operation because the P-600 has very large capacity heat sinks and is well designed for natural air flow and effective heat dissipation.

However, forced ventilation is effective in case the unit is used under extremely poor ventilation conditions or operated continuously for long periods at high power. Therefore space is provided for fan installation. It is recommended that you consult your Accuphase dealer regarding this matter.

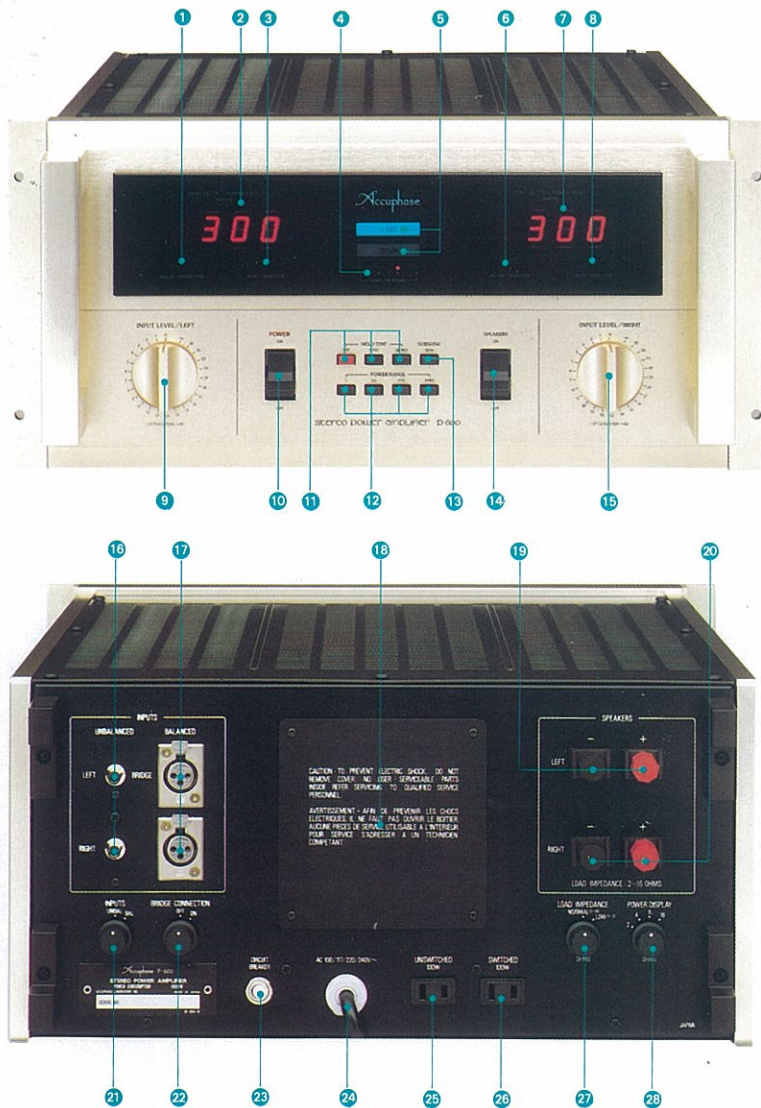

- 1 Bridge connection indicator
- 2 L-channel and bridge connection LED PEAK OUTPUT POWER display (WATTS)
- 3 Power display RESET INDICATOR
- 4 LOAD IMPedance indicator (OHMS)
- 5 HOLD TIME display
- 6 LOW IMPedance OPERATION indicator
- 7 R-channel LED PEAK OUTPUT POWER display (WATTS)
- 8 Power display RESET INDICATOR
- 9 L-channel and bridge connection INPUT LEVEL control (1 dB steps to -20 dB)
- 10 POWER switch
- 11 Power display HOLD TIME selector switch OFF, 3 SEC, 30 MIN
- 12 POWER RANGE selector switch 1, 0.1, 0.01, 0.001
- 13 SUBSONIC filter 10 Hz, -12 dB/oct
- 14 SPEAKERS ON/OFF switch
- 15 R-channel input level control (1 dB steps to -20 dB)
- 16 INPUT jacks (UNBALANCED/20 k ohm)
- 17 XLR (cannon) type input jacks (BALANCED/600 ohm)
- 18 Mounting location for forced ventilation fan
- 19 L-channel output
- 20 R-channel output
- 21 INPUT selector switch UNBALANCED/BALANCED
- 22 BRIDGE CONNECTION switch ON, OFF
- 23 CIRCUIT BREAKER
- 24 AC power cord
- 25 AC outlet (UNSWITCHED)
- 26 AC outlet (SWITCHED)
- 27 LOAD IMPEDANCE selector switch NORMAL (2-16 ohm), LOW (1-2 ohm)
- 28 POWER DISPLAY impedance selector switch 2, 4, 8, 16

GUARANTY SPECIFICATIONS

● PERFORMANCE GUARANTY:

All Accuphase product specifications are guaranteed as stated.

● CONTINUOUS AVERAGE POWER OUTPUT (EIA):

STEREOPHONIC MODE: Both channels driven, from 20 Hz to 20,000 Hz with no more than 0.02% total harmonic distortion.

NORMAL LOAD IMPEDANCE OPERATION:
700 watts per channel, min. RMS, at 2-ohm
500 watts per channel, min. RMS, at 4-ohm
300 watts per channel, min. RMS, at 8-ohm
150 watts per channel, min. RMS, at 16-ohm

LOW LOAD IMPEDANCE OPERATION:
450 watts per channel, min. RMS, at 1-ohm
300 watts per channel, min. RMS, at 2-ohm

MONOPHONIC MODE (Bridging Connection):
From 20 Hz to 20,000 Hz with no more than 0.02% total harmonic distortion.

NORMAL LOAD IMPEDANCE OPERATION:
1,400 watts, min. RMS, at 4-ohm
1,000 watts, min. RMS, at 8-ohm
600 watts, min. RMS, at 16-ohm

LOW LOAD IMPEDANCE OPERATION:
900 watts, min. RMS, at 2-ohm
600 watts, min. RMS, at 4-ohm

● TOTAL HARMONIC DISTORTION:

STEREOPHONIC MODE:

Both channels driven, from 20 Hz to 20,000 Hz at any power output from 1/4 watt to rated power:
0.02% max., at 1-ohm to 2-ohm
0.01% max., at 4-ohm to 16-ohm

MONOPHONIC MODE (Bridging Connection):
From 20 Hz to 20,000 Hz at any power output from 1/4 watt to rated power.

0.02% max., at 2-ohm to 4-ohm
0.01% max., at 8-ohm to 16-ohm

● INTERMODULATION DISTORTION (EIA):

Will not exceed 0.01% at rated power output

● FREQUENCY RESPONSE (EIA):

20 Hz to 20,000 Hz, +0, -0.2 dB for rated output at the maximum level control

0.5 Hz to 250,000 Hz, +0, -3.0 dB for 1 watt output at the maximum level control

0.5 Hz to 150,000 Hz, +0, -3.0 dB for 1 watt output at -6 dB attenuation

● VOLTAGE AMPLIFICATION IN DECIBELS:

27.8 dB at STEREOPHONIC MODE

33.8 dB at MONOPHONIC MODE (Bridging Connection)

● OUTPUT LOAD IMPEDANCE:

1-ohm to 16-ohm at STEREOPHONIC MODE

2-ohm to 16-ohm at MONOPHONIC MODE (Bridging Connection)

● DAMPING FACTOR: (EIA at 50 Hz/8-ohm)

300 at STEREOPHONIC MODE

150 at MONOPHONIC MODE (Bridging Connection)

● INPUT SENSITIVITY AND IMPEDANCE:

STEREOPHONIC MODE:

8-ohm load at NORMAL LOAD IMPEDANCE OPERATION

2.0 V, 20 k ohms/600 ohms, for rated output at the maximum level control

2-ohm load at LOW LOAD IMPEDANCE OPERATION

1.0 V, 20 k ohms/600 ohms, for rated output at the maximum level control

MONOPHONIC MODE (Bridging Connection):

8-ohm load at NORMAL LOAD IMPEDANCE OPERATION

1.83 V, 20 k ohms/600 ohms, for rated output at the maximum level control

2-ohm load at LOW LOAD IMPEDANCE OPERATION

0.91 V, 20 k ohms/600 ohms, for rated output at the maximum level control

*20 k ohms UNBALANCED input and 600 ohms BALANCED input selectable by INPUTS selector on the rear panel

● A-WEIGHTED SIGNAL-TO-NOISE RATIO:

STEREOPHONIC MODE (at NORMAL LOAD IMPEDANCE OPERATION):

125 dB below rated output, inputs shorted
100 dB at 1 watt output, terminated with 1 k-ohm (EIA A-Weighted)

MONOPHONIC MODE (Bridging Connection at NORMAL LOAD IMPEDANCE OPERATION):

115 dB below rated output, inputs shorted
90 dB at 1 watt output, terminated with 1 k-ohm (EIA A-Weighted)

● SUBSONIC FILTER: 10 Hz cutoff, -12 dB/oct.

● DIGITAL POWER METER:

TYPE: Peak Power Display in wattage

DISPLAY DIGIT: Three digits by LED digital display

DYNAMIC DISPLAY RANGE: Digital read-out from 0.001 W to 999 W depending on the setting of the Power Range Switch

DISPLAY LOAD IMPEDANCE: Selectable by switching, 2-ohm, 4-ohm, 8-ohm and 16-ohm

SAMPLING HOLD TIME: 3 SEC and 30 MIN

FREQUENCY RESPONSE: 20 Hz to 20,000 Hz, +0 dB, -0.2 dB

PULSE RESPONSE TOLERANCE: +0 dB, -0.4 dB with a half-wave of 100 Hz sine-wave

● SEMICONDUCTOR COMPLEMENT:

90 Tr's, 8 FETs, 36 Cs, 104 Di's and 8 LEDs

● POWER REQUIREMENT:

Voltage selection by rewiring for 100 V, 117 V, 220 V and 240 V 50/60Hz operation

● POWER CONSUMPTION (NORMAL LOAD IMPEDANCE OPERATION):

165 watts at zero signal output
1,100 watts at rated power output into 8 ohms load

● DIMENSIONS:

480 mm (18-15/16 inches) width, 232 mm (9-3/16 inches) max. height, 476 mm (18-12/16 inches) depth

● WEIGHT:

38.5 kg (84.7 lbs) net, 45.0 kg (99.0 lbs) in shipping carton

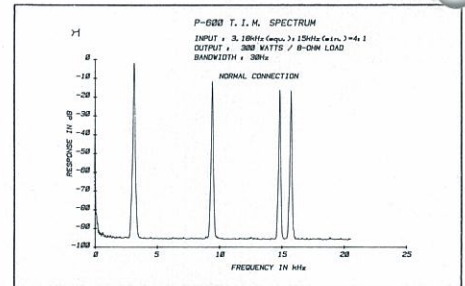
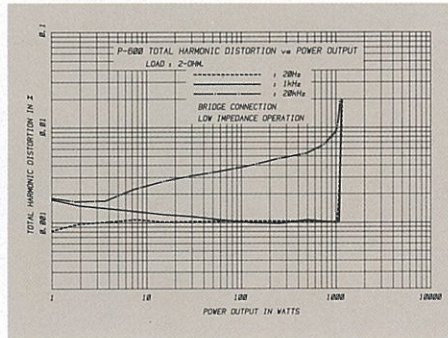
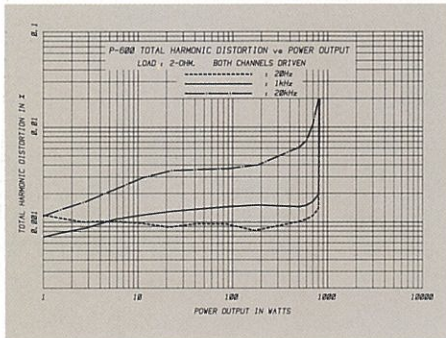
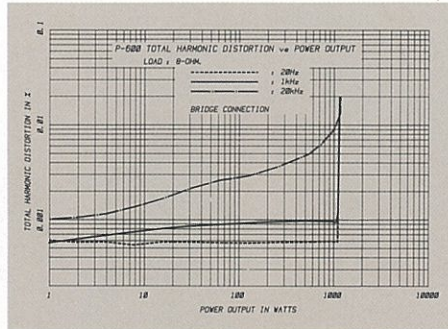
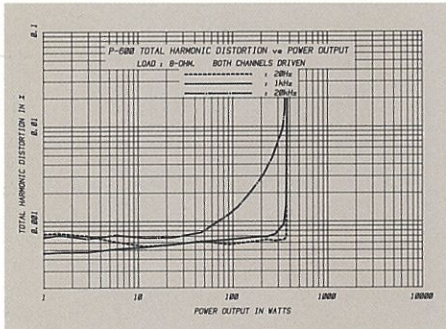
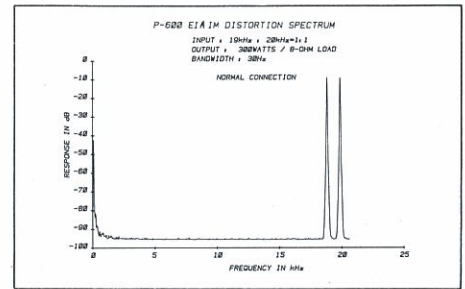
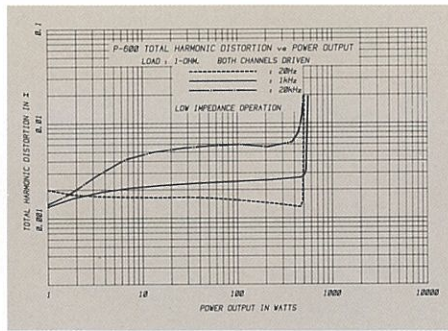
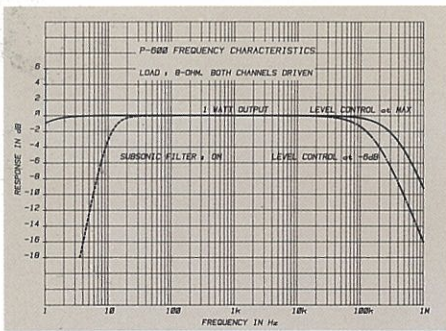

The above data shows the spectrums of intermodulation distortion for the P-600 as measured by the EIA measurement method. Amplitudes of a 19 kHz and 20 kHz input signals are shown at the right side. Any intermodulation created by these two signals would appear as spectrum peaks at 1 kHz intervals, across the frequency bandwidth. This data shows them to be hardly noticeable, confirming that IM distortion is less than -93 dB (0.0022%).

Another form of IM distortion would appear at 39 kHz, the sum of the two input signal frequencies ($19+20=39$ kHz). Such a distortion, even if it existed, would be inconsequential because it is far beyond the audible range. In the P-600, this form of IM distortion is also less than -93 dB.

The above data shows the spectrum characteristics of transient intermodulation distortion for the P-600 when two mixed input signals, a 3.18 kHz square wave and a 15 kHz sine wave, are used. Since harmonics of square waves appear almost infinitely at odd-number multiples, for example in this case at 9.54 kHz (3rd harmonic) and 15.9 kHz (5th harmonic), they can create, together with the 15 kHz input sine wave, intermodulated spectrums at frequencies where input signals are absent. For example, if the third harmonic of the 3.18 kHz square wave (9.54 kHz) and the 15 kHz input signal intermodulate, a spectrum can appear at the difference of their frequencies, or 5.46 kHz ($15-9.54=5.46$ kHz). However, the above data shows no spectrum above -93 dB at that frequency. This confirms that TIM distortion is less than 0.0022%.

